

STEREO AUDIO CODEC WITH USB INTERFACE, SINGLE-ENDED ANALOG INPUT/OUTPUT AND S/PDIF

FEATURES

- **PCM2901: Without S/PDIF**
- **PCM2903: With S/PDIF**
- **On-Chip USB Interface**
 - With Full-Speed Transceivers
 - Fully Compliant With USB 1.1 Specification
 - Certified by USB-IF
 - Partially Programmable Descriptors ⁽¹⁾
 - USB Adaptive Mode for Playback
 - USB Asynchronous Mode for Record
 - Self-Powered
- **16-Bit Delta-Sigma ADC and DAC**
- **Sampling Rates**
 - DAC: 32, 44.1, 48 kHz
 - ADC: 8, 11.025, 16, 22.05, 32, 44.1, 48 kHz
- **On-Chip Clock Generator With Single 12-MHz Clock Source**
- **Single Power Supply: 3.3 V Typical**
- **Stereo ADC**
 - Analog Performance at $V_{CC} = V_{CCP1} = V_{CCP2} = V_{CCX} = V_{DD} = 3.3\text{ V}$
 - THD+N = 0.01%
 - SNR = 89 dB
 - Dynamic Range = 89 dB
 - Decimation Digital Filter
 - Pass-Band Ripple = $\pm 0.05\text{ dB}$
 - Stop-Band Attenuation = -65 dB
 - Single-Ended Voltage Input
 - Antialiasing Filter Included
 - Digital LCF Included
- **Stereo DAC**
 - Analog Performance at $V_{CC} = V_{CCP1} = V_{CCP2} = V_{CCX} = V_{DD} = 3.3\text{ V}$
 - THD+N = 0.005%
 - SNR = 96 dB
 - Dynamic Range = 93 dB
 - Oversampling Digital Filter
 - Pass-Band Ripple = $\pm 0.1\text{ dB}$
 - Stop-Band Attenuation = -43 dB
 - Single-Ended Voltage Output
 - Analog LPF Included
- **Multifunctions**
 - Human Interface Device (HID) Volume \pm Control and Mute Control
 - Suspend Flag
- **Package: 28-Pin SSOP**

APPLICATIONS

- USB Audio Speaker
- USB Headset
- USB Monitor
- USB Audio Interface Box

DESCRIPTION

The PCM2901/2903 is TI's single-chip USB stereo audio codec with USB-compliant full-speed protocol controller and S/PDIF (only PCM2903). The USB protocol controller works with no software code, but the USB descriptors can be modified in some areas (for example, vendor ID/product ID). The PCM2901/2903 employs SpAct™ architecture, TI's unique system that recovers the audio clock from USB packet data. On-chip analog PLLs with SpAct enable playback and record with low clock jitter and with independent playback and record sampling rates.

(1) The descriptor can be modified by changing a mask.



Please be aware that an important notice concerning availability, standard warranty, and use in critical applications of Texas Instruments semiconductor products and disclaimers thereto appears at the end of this data sheet.

SpAct is a trademark of Texas Instruments.

System Two, Audio Precision are trademarks of Audio Precision, Inc.

All other trademarks are the property of their respective owners.



This integrated circuit can be damaged by ESD. Texas Instruments recommends that all integrated circuits be handled with appropriate precautions. Failure to observe proper handling and installation procedures can cause damage.

ESD damage can range from subtle performance degradation to complete device failure. Precision integrated circuits may be more susceptible to damage because very small parametric changes could cause the device not to meet its published specifications.

ORDERING INFORMATION

PCM2901						
PRODUCT	PACKAGE-LEAD	PACKAGE DESIGNATOR	SPECIFIED TEMPERATURE RANGE	PACKAGE MARKING	ORDERING NUMBER ⁽¹⁾	TRANSPORT MEDIA
PCM2901E	SSOP-28	28DB	–25°C to 85°C	PCM2901E	PCM2901E	Rails
					PCM2903E/2K	Tape and reel

(1) Models with a slash (/) are available only in tape and reel in the quantities indicated (e.g., /2K indicates 2000 devices per reel). Ordering 2000 pieces of PCM2901E/2K gets a single 2000-piece tape and reel.

PCM2903						
PRODUCT	PACKAGE-LEAD	PACKAGE DESIGNATOR	SPECIFIED TEMPERATURE RANGE	PACKAGE MARKING	ORDERING NUMBER ⁽¹⁾	TRANSPORT MEDIA
PCM2903E	SSOP-28	28DB	–25°C to 85°C	PCM2903E	PCM2903E	Rails
					PCM2903E/2K	Tape and reel

(1) Models with a slash (/) are available only in tape and reel in the quantities indicated (e.g., /2K indicates 2000 devices per reel). Ordering 2000 pieces of PCM2903E/2K gets a single 2000-piece tape and reel.

ABSOLUTE MAXIMUM RATINGS

over operating free-air temperature range (unless otherwise noted) ⁽¹⁾

		PCM2901/PCM2903	UNIT
Supply voltage, V_{CC} , V_{CCP1} , V_{CCP2} , V_{CCX} , V_{DD}		–0.3 to 4	V
Supply voltage differences, V_{CC} , V_{CCP1} , V_{CCP2} , V_{CCX} , V_{DD}		±0.1	V
Ground voltage differences, AGNDC, AGNDP, AGNDX, DGND, DGNDU		±0.1	V
Digital input voltage	SEL0, SEL1, TEST0 (DIN) ⁽²⁾	–0.3 to 6.5	V
	D+, D–, HID0, HID1, HID2, XTI, XTO, TEST1 (DOUT) ⁽²⁾ , SSPND	–0.3 to $(V_{DD} + 0.3) < 4$	V
Analog input voltage V_{INL} , V_{INR} , V_{COM} , V_{OUTR} , V_{OUTL}		–0.3 to $(V_{CC} + 0.3) < 4$	V
Input current (any pins except supplies)		±10	mA
Ambient temperature under bias		–40 to 125	°C
Storage temperature, T_{stg}		–55 to 150	°C
Junction temperature T_J		150	°C
Lead temperature (soldering)		260	°C, 5 s
Package temperature (IR reflow, peak)		250	°C

(1) Stresses beyond those listed under *absolute maximum ratings* may cause permanent damage to the device. These are stress ratings only, and functional operation of the device at these or any other conditions beyond those indicated under *recommended operating conditions* is not implied. Exposure to absolute-maximum-rated conditions for extended periods may affect device reliability.

(2) (): PCM2903

ELECTRICAL CHARACTERISTICS

all specifications at $T_A = 25^\circ\text{C}$, $V_{\text{CCC}} = V_{\text{CCP1}} = V_{\text{CCP2}} = V_{\text{CCX}} = V_{\text{DD}} = 3.3\text{ V}$, $f_S = 44.1\text{ kHz}$, $f_{\text{IN}} = 1\text{ kHz}$, 16-bit data, unless otherwise noted

PARAMETER		TEST CONDITIONS	MIN	TYP	MAX	UNIT
DIGITAL INPUT/OUTPUT						
Host interface		Apply USB Revision 1.1, full speed				
Audio data format		USB isochronous data format				
INPUT LOGIC						
V_{IH}	High-level input voltage	D+, D–	2		V_{DD}	VDC
		XTI, HID0, HID1, and HID2	$0.7 V_{\text{DD}}$		V_{DD}	
		SEL0, SEL1	2		5.25	
		DIN (PCM2903)	$0.7 V_{\text{DD}}$		5.25	
V_{IL}	Low-level input voltage	D+, D–	V_{DD}		0.8	VDC
		XTI, HID0, HID1, and HID2			$0.3 V_{\text{DD}}$	
		SEL0, SEL1			0.8	
		DIN (PCM2903)			$0.3 V_{\text{DD}}$	
I_{IH}	High-level input current	D+, D–, XTI, SEL0, SEL1	$V_{\text{IN}} = 3.3\text{ V}$		± 10	μA
		HID0, HID1, and HID2	$V_{\text{IN}} = 3.3\text{ V}$		50 80	
		DIN (PCM2903)	$V_{\text{IN}} = 3.3\text{ V}$		65 100	
I_{IL}	Low-level input current	D+, D–, XTI, SEL0, SEL1	$V_{\text{IN}} = 0\text{ V}$		± 10	μA
		HID0, HID1, and HID2	$V_{\text{IN}} = 0\text{ V}$		± 10	
		DIN (PCM2903)	$V_{\text{IN}} = 0\text{ V}$		± 10	
OUTPUT LOGIC						
V_{OH}	High-level output voltage	D+, D–		2.8		VDC
		DOUT (PCM2903)	$I_{\text{OH}} = -4\text{ mA}$	2.8		
		SSPND	$I_{\text{OH}} = -2\text{ mA}$	2.8		
V_{OL}	Low-level output voltage	D+, D–			0.3	VDC
		DOUT (PCM2903)	$I_{\text{OL}} = 4\text{ mA}$		0.5	
		SSPND	$I_{\text{OL}} = 2\text{ mA}$		0.5	
CLOCK FREQUENCY						
Input clock frequency, XTI			11.994	12	12.006	MHz

ELECTRICAL CHARACTERISTICS

All specifications at $T_A = 25^\circ\text{C}$, $V_{\text{CC}} = V_{\text{CCP1}} = V_{\text{CCP2}} = V_{\text{CCX}} = V_{\text{DD}} = 3.3\text{ V}$, $f_S = 44.1\text{ kHz}$, $f_{\text{IN}} = 1\text{ kHz}$, 16-bit data, unless otherwise noted

PARAMETER		TEST CONDITIONS	MIN	TYP	MAX	UNIT
ADC CHARACTERISTICS						
Resolution				8, 16		bits
Audio data channel				1, 2		channel
Clock Frequency						
f_S	Sampling frequencies		8, 11.025, 16, 22.05, 32, 44.1, 48			kHz
DC Accuracy						
Gain mismatch, channel-to-channel				± 1	± 5	% of FSR
Gain error				± 2	± 10	% of FSR
Bipolar zero error				± 0		% of FSR
Dynamic Performance⁽¹⁾						
THD+N	Total harmonic distortion plus noise	$V_{\text{IN}} = -0.5\text{ dB}$		0.01%	0.02%	
		$V_{\text{IN}} = -60\text{ dB}$		5%		
Dynamic range		A-weighted	81	89		dB
SNR	Signal-to-noise ratio	A-weighted	81	89		dB
Channel separation			80	85		dB
Analog Input						
Input voltage				$0.6 V_{\text{CC}}$		Vp-p
Center voltage				$0.5 V_{\text{CC}}$		V
Input impedance				30		k Ω
Antialiasing filter frequency response		-3 dB		150		kHz
		$f_{\text{IN}} = 20\text{ kHz}$		-0.08		dB
Digital Filter Performance						
Pass band					$0.454 f_S$	Hz
Stop band			$0.563 f_S$			Hz
Pass-band ripple					± 0.05	dB
Stop-band attenuation			-65			dB
t_d	Delay time			$17.4/f_S$		s
LCF frequency response		-3 dB		$0.078 f_S$		MHz

(1) $f_{\text{IN}} = 1\text{ kHz}$, using a System Two™ audio measurement system by Audio Precision™ in RMS mode with a 20-kHz LPF and 400-Hz HPF in the calculation.

ELECTRICAL CHARACTERISTICS

all specifications at $T_A = 25^\circ\text{C}$, $V_{\text{CC}} = V_{\text{CCP1}} = V_{\text{CCP2}} = V_{\text{CCX}} = V_{\text{DD}} = 3.3\text{ V}$, $f_S = 44.1\text{ kHz}$, $f_{\text{IN}} = 1\text{ kHz}$, 16-bit data, unless otherwise noted

PARAMETER		TEST CONDITIONS	MIN	TYP	MAX	UNIT
DAC CHARACTERISTICS						
Resolution			8, 16			bits
Audio data channel			1, 2			channel
Clock Frequency						
f_S	Sampling frequencies		32, 44.1, 48			kHz
DC Accuracy						
Gain mismatch channel-to-channel			± 1	± 5		% of FSR
Gain error			± 2	± 10		% of FSR
Bipolar zero error			± 2			% of FSR
Dynamic Performance⁽¹⁾						
THD+N	Total harmonic distortion plus noise	$V_{\text{OUT}} = 0\text{ dB}$	0.005%	0.016%		
		$V_{\text{OUT}} = -60\text{ dB}$	3%			
Dynamic range		EIAJ, A-weighted	87	93		dB
SNR	Signal-to-noise ratio	EIAJ, A-weighted	90	96		dB
Channel separation			86	92		dB
Analog Output						
V_O	Output voltage		0.6 V_{CC}			Vp-p
Center voltage			0.5 V_{CC}			V
Load impedance		AC coupling	10			k Ω
LPF frequency response		-3 dB	250			kHz
		$f = 20\text{ kHz}$	-0.03			dB
Digital Filter Performance						
Pass band			0.445 f_S			Hz
Stop band			0.555 f_S			Hz
Pass-band ripple			± 0.1			dB
Stop-band attenuation			-43			dB
t_d	Delay time		14.3/ f_S			s
POWER SUPPLY REQUIREMENTS						
Voltage range (V_{DD} , V_{CC} , V_{CCP1} , V_{CCP2} , V_{CCX})			3	3.3	3.6	VDC
Supply current		ADC, DAC operation	54		70	mA
		Suspend mode ⁽²⁾	210			μA
P_D	Power dissipation	ADC, DAC operation	178		252	mW
		Suspend mode ⁽²⁾	0.69			
TEMPERATURE RANGE						
Operaton temperature			-25		85	$^\circ\text{C}$
θ_{JA}	Thermal resistance		100			$^\circ\text{C/W}$

(1) $f_{\text{OUT}} = 1\text{ kHz}$, using a System Two audio measurement system by Audio Precision in RMS mode with a 20-kHz LPF and 400-Hz HPF.

(2) Under USB suspend state

PIN ASSIGNMENTS

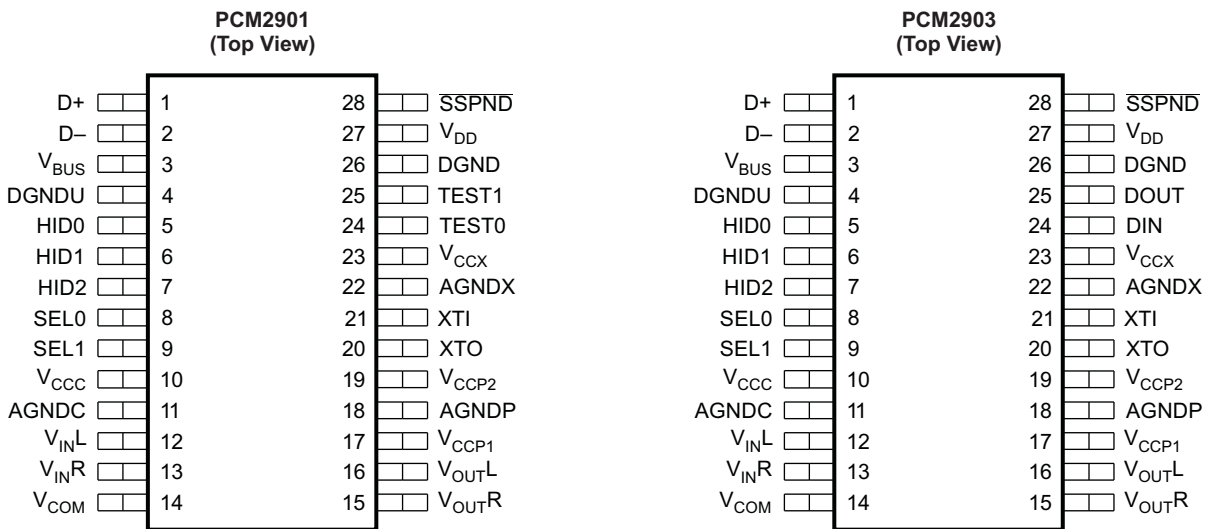

P0007-07

PCM2901 TERMINAL FUNCTIONS

TERMINAL		I/O	DESCRIPTION
NAME	NO.		
AGNDC	11	–	Analog ground for codec
AGNDP	18	–	Analog ground for PLL
AGNDX	22	–	Analog ground for oscillator
D–	2	I/O	USB differential input/output minus ⁽¹⁾
D+	1	I/O	USB differential input/output plus ⁽¹⁾
DGND	26	–	Digital ground
DGNDU	4	–	Digital ground for USB transceiver
HID0	5	I	HID key state input (mute), active-high ⁽²⁾
HID1	6	I	HID key state input (volume up), active-high ⁽²⁾
HID2	7	I	HID key state input (volume down), active-high ⁽²⁾
SEL0	8	I	Must be set to high ⁽³⁾
SEL1	9	I	Connected to the USB port of V _{BUS} ⁽³⁾
SSPND	28	O	Suspend flag, active-low (Low: suspend, High: operational)
TEST0	24	I	Test pin, must be connected to GND
TEST1	25	O	Test pin, must be left open
V _{BUS}	3	–	Must be connected to V _{DD}
V _{CC}	10	–	Analog power supply for codec ⁽⁴⁾
V _{CCP1}	17	–	Analog power supply for PLL ⁽⁴⁾
V _{CCP2}	19	–	Analog power supply for PLL ⁽⁴⁾
V _{CCX}	23	–	Analog power supply for oscillator ⁽⁴⁾
V _{COM}	14	–	Common for ADC/DAC (V _{CC} /2) ⁽⁴⁾
V _{DD}	27	–	Digital power supply ⁽⁴⁾
V _{INL}	12	I	ADC analog input for L-channel
V _{INR}	13	I	ADC analog input for R-channel
V _{OUTL}	16	O	DAC analog output for L-channel
V _{OUTR}	15	O	DAC analog output for R-channel
XTI	21	I	Crystal oscillator input ⁽⁵⁾
XTO	20	O	Crystal oscillator output

(1) LV-TTL level

(2) 3.3-V CMOS-level input with internal pulldown. This pin informs the PC of serviceable control signals such as mute, volume up, or volume down, which have no direct connection with the internal DAC or ADC. See the [Interface #3](#) and [End-Points](#) sections.

(3) TTL Schmitt trigger, 5-V tolerant

(4) Connect a decoupling capacitor to GND.

(5) 3.3-V CMO- level input

PCM2903 TERMINAL FUNCTIONS

TERMINAL		I/O	DESCRIPTION
NAME	NO.		
AGNDC	11	–	Analog ground for codec
AGNDP	18	–	Analog ground for PLL
AGNDX	22	–	Analog ground for oscillator
D–	2	I/O	USB differential input/output minus ⁽¹⁾
D+	1	I/O	USB differential input/output plus ⁽¹⁾
DGND	26	–	Digital ground
DGNDU	4	–	Digital ground for USB transceiver
DIN	24	I	S/PDIF input ⁽²⁾
DOUT	25	O	S/PDIF output
HID0	5	I	HID key state input (mute), active-high ⁽³⁾
HID1	6	I	HID key state input (volume up), active-high ⁽³⁾
HID2	7	I	HID key state input (volume down), active-high ⁽³⁾
SEL0	8	I	Must be set to high ⁽⁴⁾
SEL1	9	I	Connected to the USB port of V _{BUS} ⁽⁴⁾
$\overline{\text{SSPND}}$	28	O	Suspend flag, active-low (Low: suspend, High: operational)
V _{BUS}	3	–	Must be connected to V _{DD}
V _{CC}	10	–	Analog power supply for codec ⁽⁵⁾
V _{CCP1}	17	–	Analog power supply for PLL ⁽⁵⁾
V _{CCP2}	19	–	Analog power supply for PLL ⁽⁵⁾
V _{CCX}	23	–	Analog power supply for oscillator ⁽⁵⁾
V _{COM}	14	–	Common for ADC/DAC (V _{CC} /2) ⁽⁵⁾
V _{DD}	27	–	Digital power supply ⁽⁵⁾
V _{INL}	12	I	ADC analog input for L-channel
V _{INR}	13	I	ADC analog input for R-channel
V _{OUTL}	16	O	DAC analog output for L-channel
V _{OUTR}	15	O	DAC analog output for R-channel
XTI	21	I	Crystal oscillator input ⁽⁶⁾
XTO	20	O	Crystal oscillator output

(1) LV-TTL level

(2) 3.3-V CMOS-level input with internal pulldown, 5-V tolerant

(3) 3.3-V CMOS-level input with internal pulldown. This pin informs the PC of serviceable control signals such as mute, volume up, or volume down, which have no direct connection with the internal DAC or ADC. See the [Interface #3](#) and [End-Points](#) sections.

(4) TTL Schmitt trigger, 5-V tolerant

(5) Connect a decoupling capacitor to GND.

(6) 3.3-V CMOS-level input

PCM2901 FUNCTIONAL BLOCK DIAGRAM

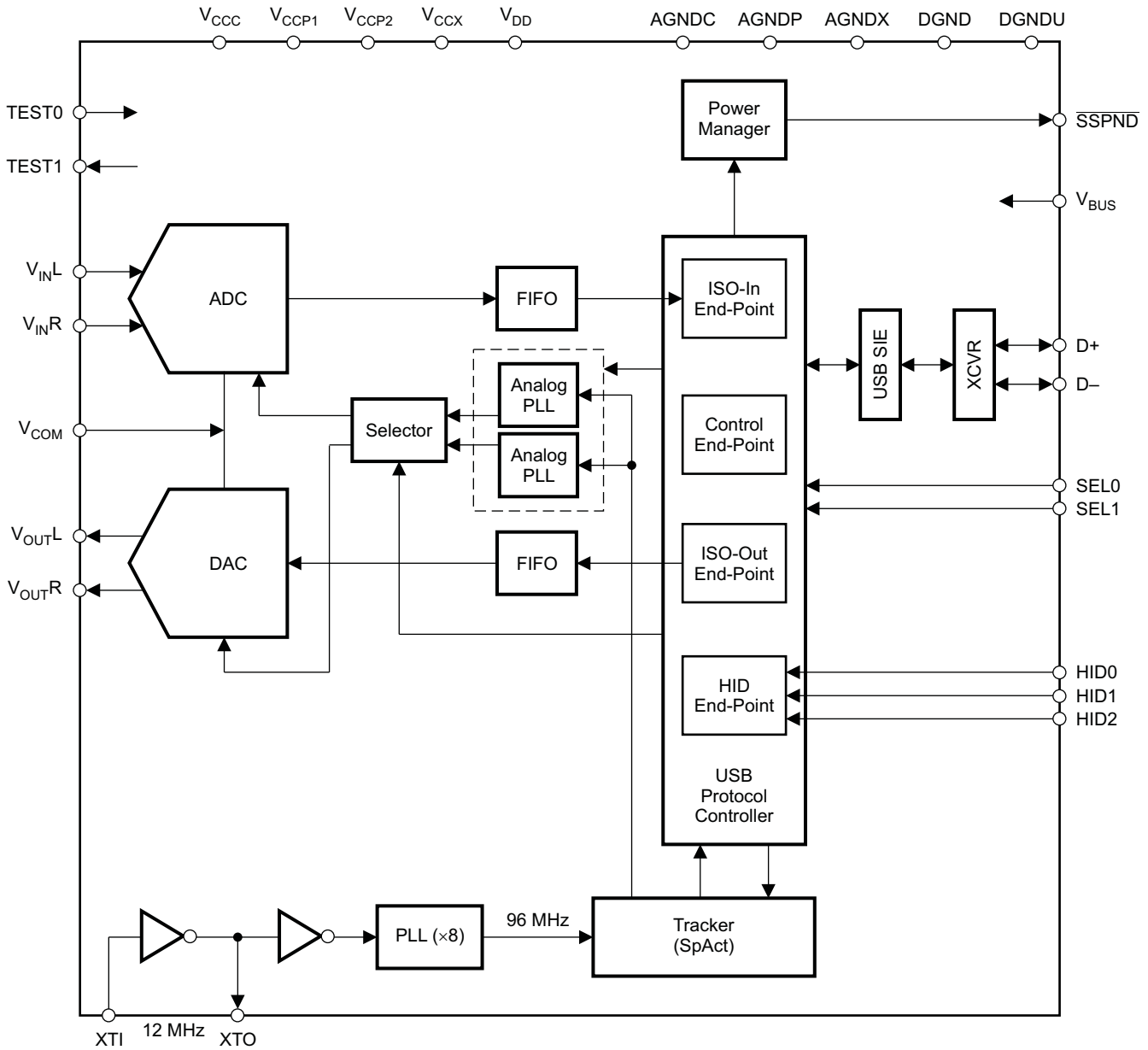

B0238-02

PCM2903 FUNCTIONAL BLOCK DIAGRAM

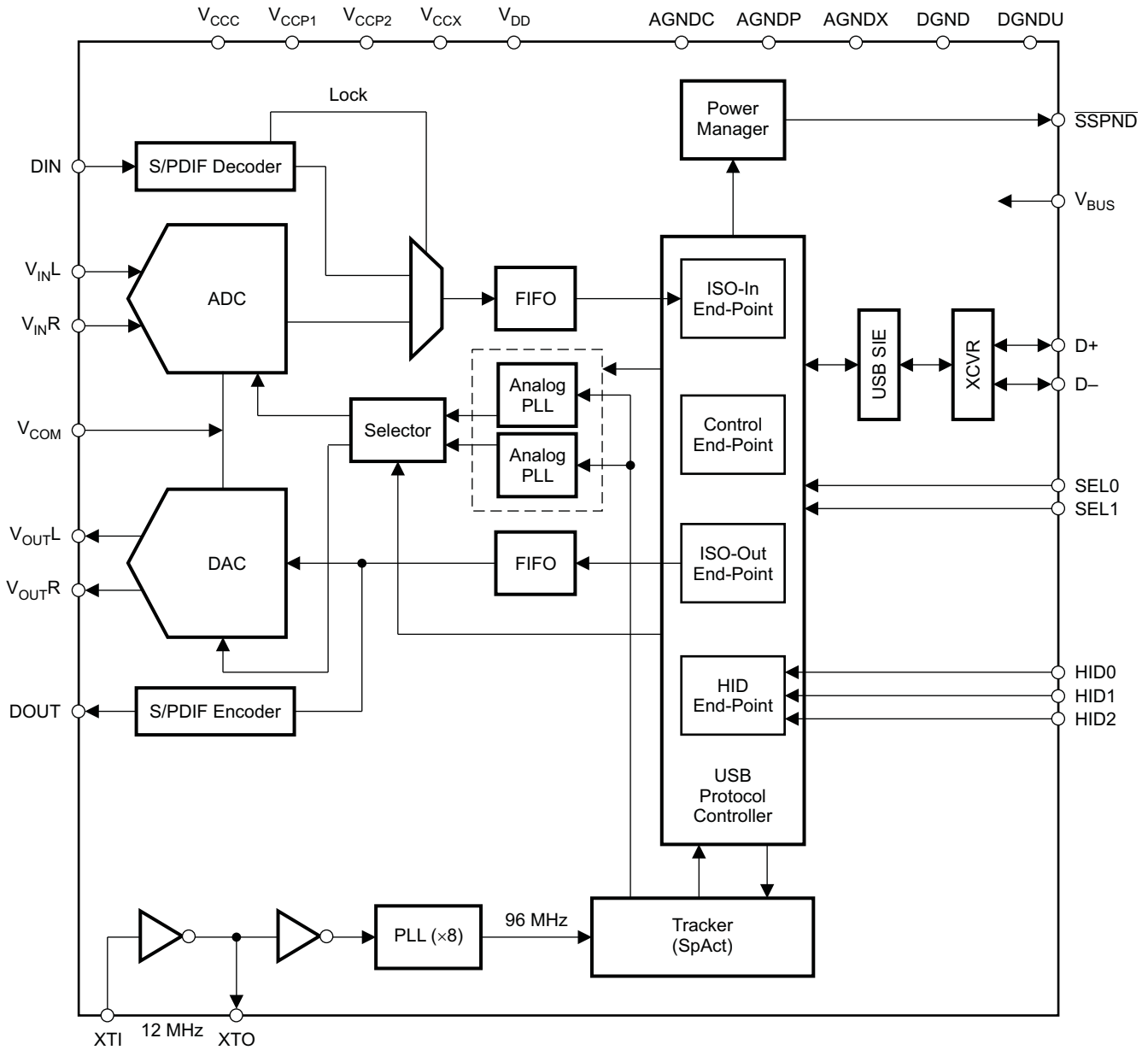

B0239-02

PCM2901/2903 BLOCK DIAGRAM OF ANALOG FRONT-END (RIGHT CHANNEL)

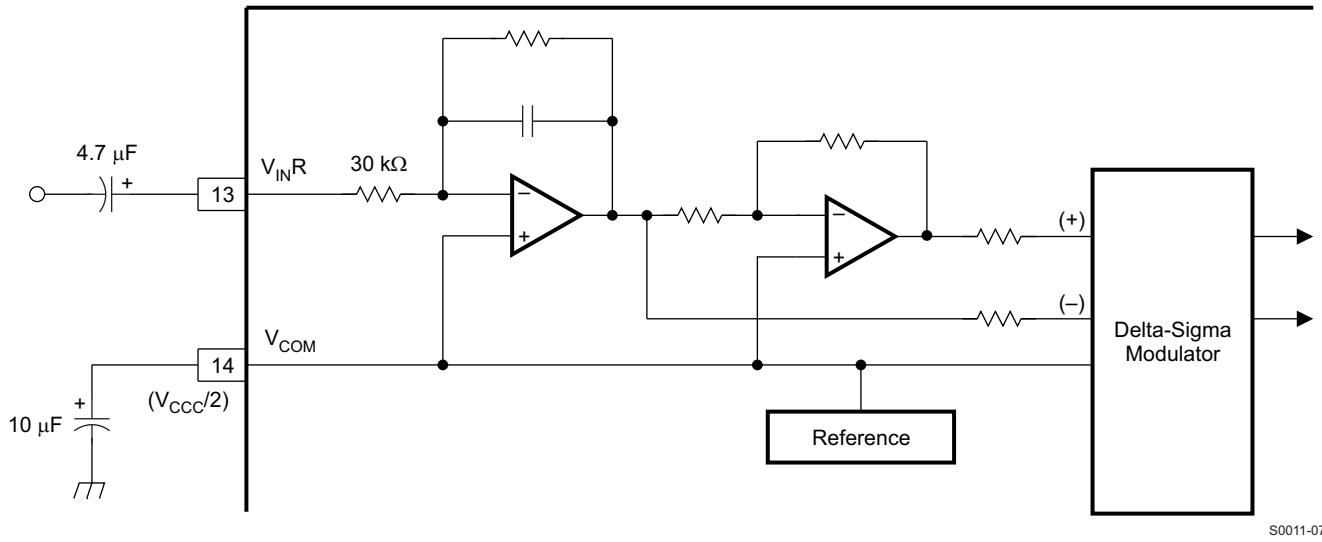

TYPICAL CHARACTERISTICS

All specifications at $T_A = 25^\circ\text{C}$, $V_{DD} = V_{CC} = V_{CCP1} = V_{CCP2} = V_{CCx} = 3.3\text{ V}$, $f_s = 44.1\text{ kHz}$, $f_{IN} = 1\text{ kHz}$, 16-bit data, unless otherwise noted.

ADC

TOTAL HARMONIC DISTORTION + NOISE at -0.5 dB
vs
FREE-AIR TEMPERATURE

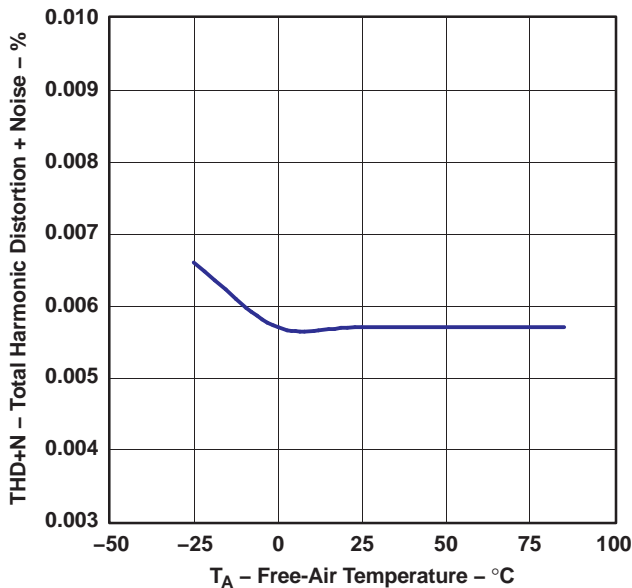

Figure 1.

DYNAMIC RANGE and SNR
vs
FREE-AIR TEMPERATURE

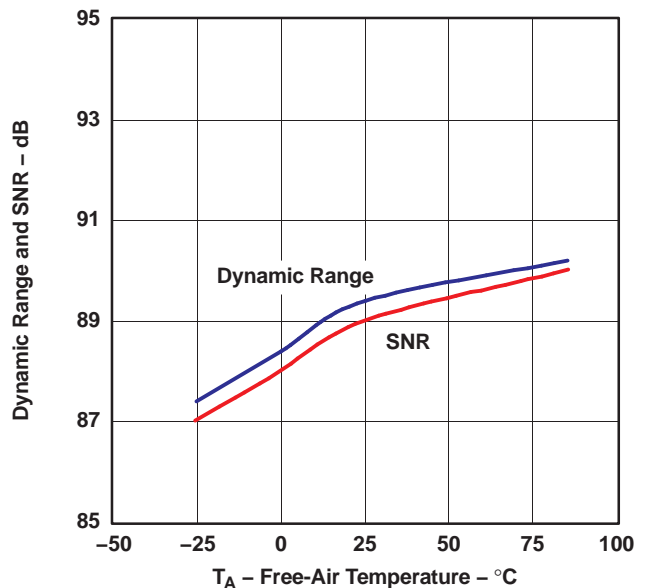
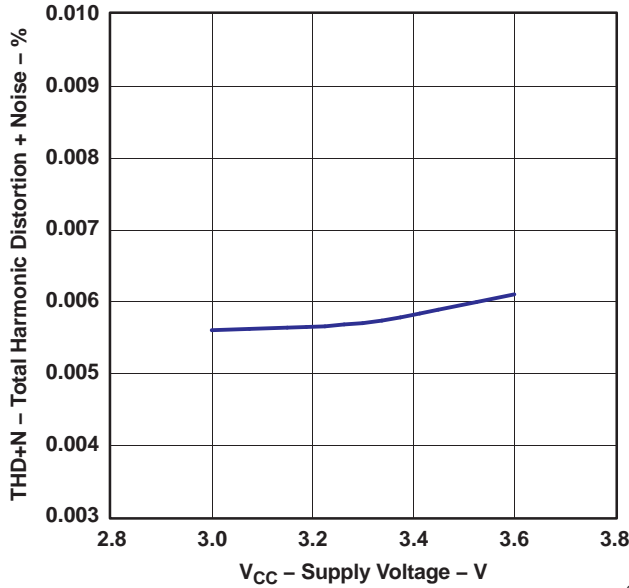

Figure 2.

TYPICAL CHARACTERISTICS (continued)

All specifications at $T_A = 25^\circ\text{C}$, $V_{DD} = V_{CC} = V_{CCP1} = V_{CCP2} = V_{CCx} = 3.3\text{ V}$, $f_s = 44.1\text{ kHz}$, $f_{IN} = 1\text{ kHz}$, 16-bit data, unless otherwise noted.

**TOTAL HARMONIC DISTORTION + NOISE at -0.5 dB
vs
SUPPLY VOLTAGE**



G003

Figure 3.

**DYNAMIC RANGE and SNR
vs
SUPPLY VOLTAGE**

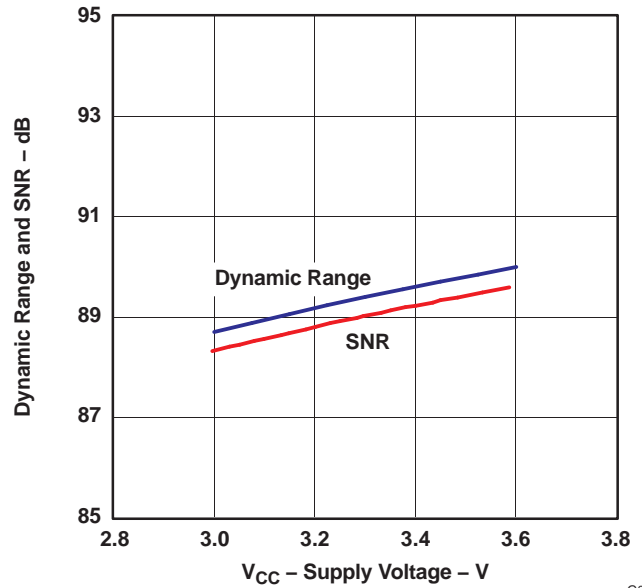

G004

Figure 4.

**TOTAL HARMONIC DISTORTION + NOISE at -0.5 dB
vs
SAMPLING FREQUENCY**

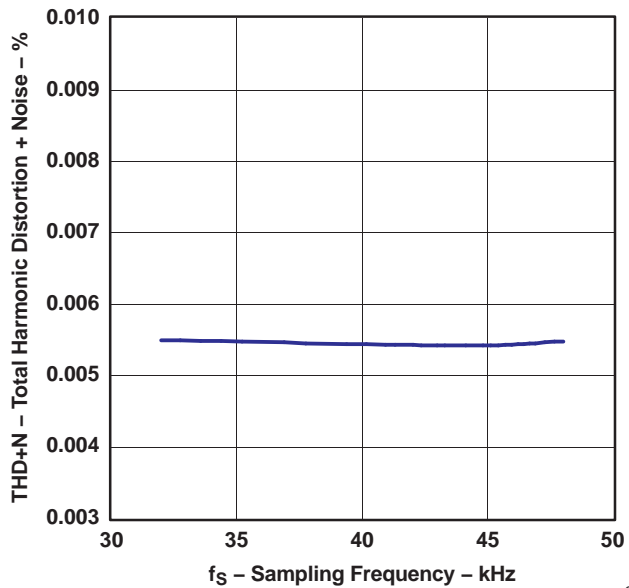

G005

Figure 5.

**DYNAMIC RANGE and SNR
vs
SAMPLING FREQUENCY**

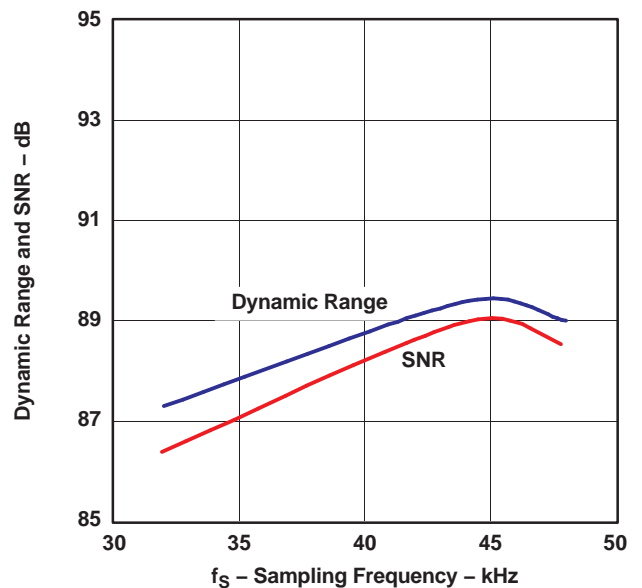

G006

Figure 6.

TYPICAL CHARACTERISTICS (continued)

All specifications at $T_A = 25^\circ\text{C}$, $V_{DD} = V_{CC} = V_{CCP1} = V_{CCP2} = V_{CCx} = 3.3\text{ V}$, $f_s = 44.1\text{ kHz}$, $f_{IN} = 1\text{ kHz}$, 16-bit data, unless otherwise noted.

DAC

TOTAL HARMONIC DISTORTION + NOISE at 0 dB
vs
FREE-AIR TEMPERATURE

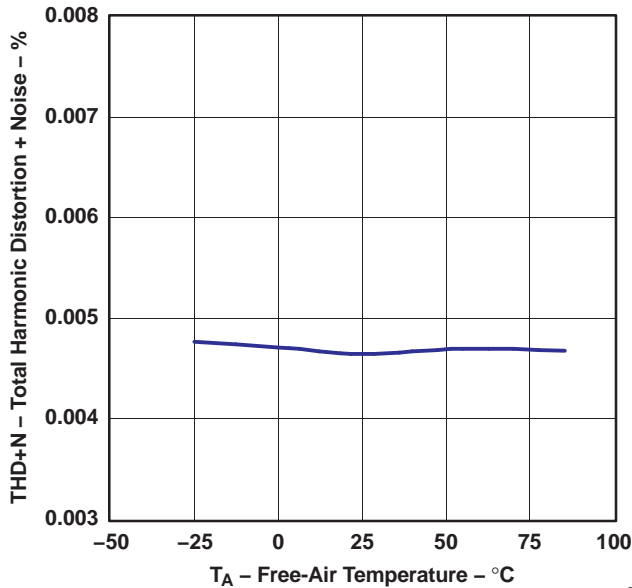

G007

Figure 7.

DYNAMIC RANGE and SNR
vs
FREE-AIR TEMPERATURE

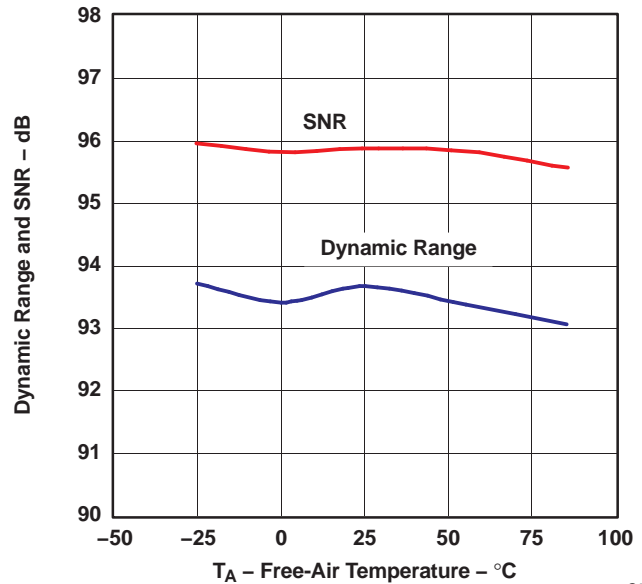

G008

Figure 8.

TOTAL HARMONIC DISTORTION + NOISE at 0 dB
vs
SUPPLY VOLTAGE

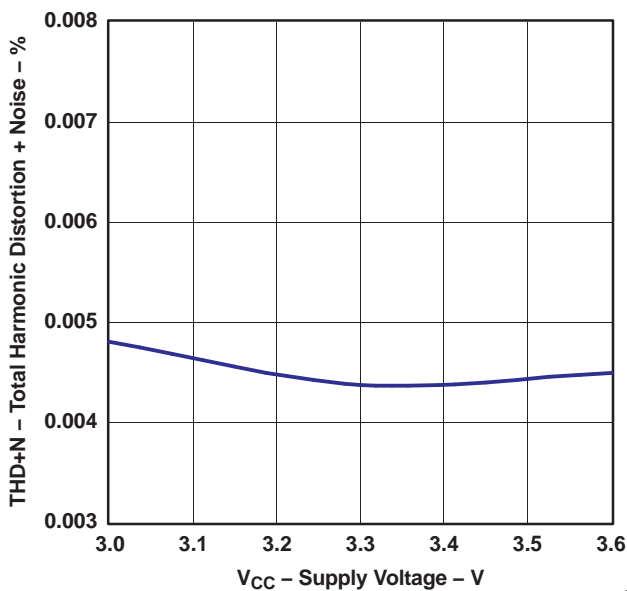

G009

Figure 9.

DYNAMIC RANGE and SNR
vs
SUPPLY VOLTAGE

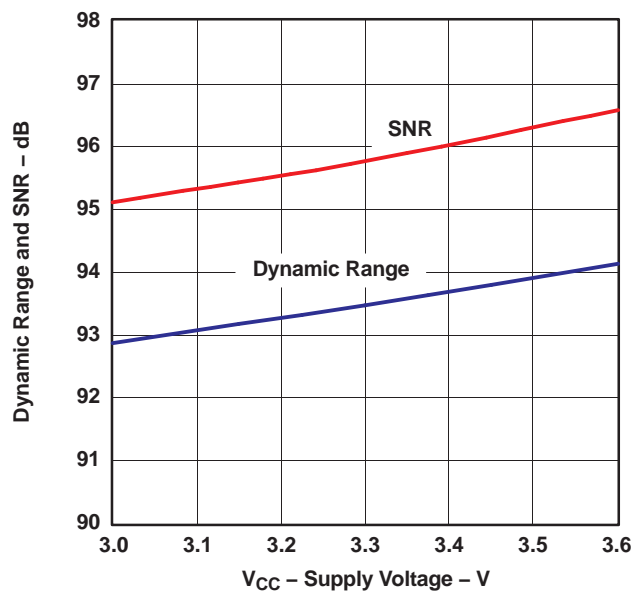

G010

Figure 10.

TYPICAL CHARACTERISTICS (continued)

All specifications at $T_A = 25^\circ\text{C}$, $V_{DD} = V_{CC} = V_{CCP1} = V_{CCP2} = V_{CCx} = 3.3\text{ V}$, $f_s = 44.1\text{ kHz}$, $f_{IN} = 1\text{ kHz}$, 16-bit data, unless otherwise noted.

**TOTAL HARMONIC DISTORTION + NOISE at 0 dB
VS
SAMPLING FREQUENCY**

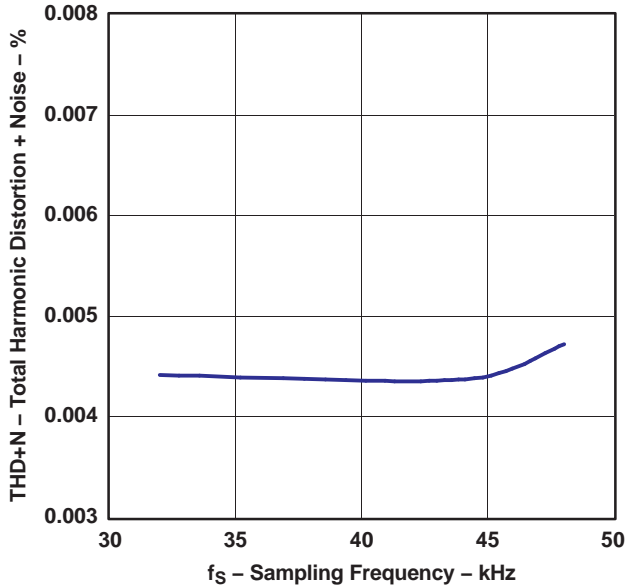

Figure 11.

G011

**DYNAMIC RANGE and SNR
VS
SAMPLING FREQUENCY**

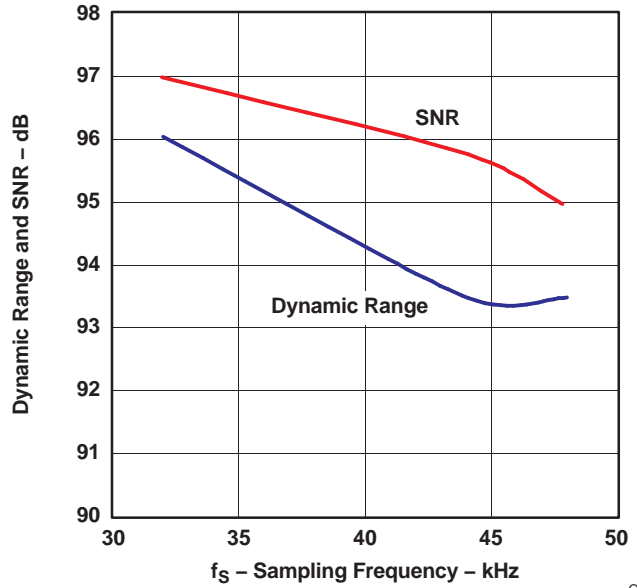

Figure 12.

G012

ADC OUTPUT SPECTRUM

OUTPUT SPECTRUM (-0.5 dB, N = 8192)

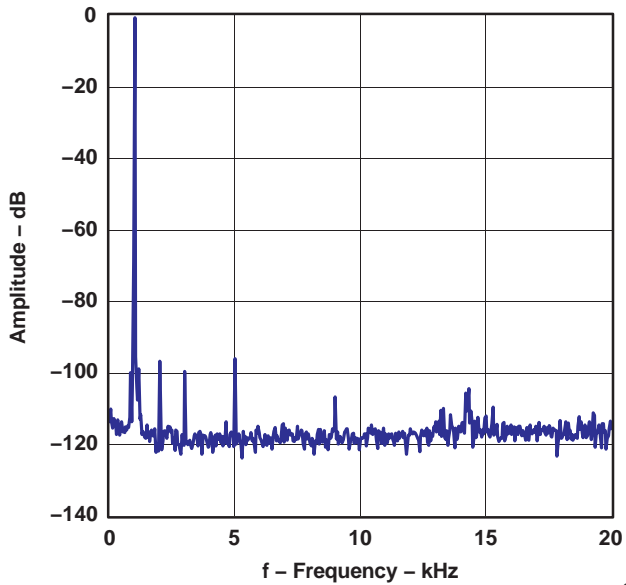

Figure 13.

G013

OUTPUT SPECTRUM (-60 dB, N = 8192)

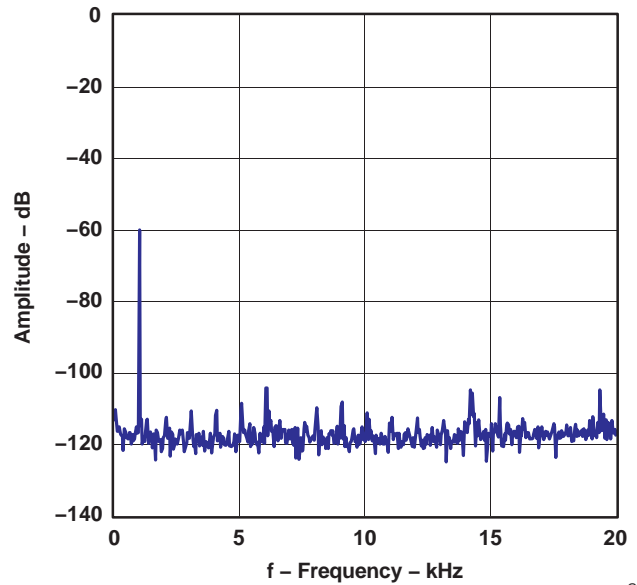

Figure 14.

G014

TYPICAL CHARACTERISTICS (continued)

All specifications at $T_A = 25^\circ\text{C}$, $V_{DD} = V_{CCC} = V_{CCP1} = V_{CCP2} = V_{CCX} = 3.3\text{ V}$, $f_s = 44.1\text{ kHz}$, $f_{IN} = 1\text{ kHz}$, 16-bit data, unless otherwise noted.

DAC OUTPUT SPECTRUM

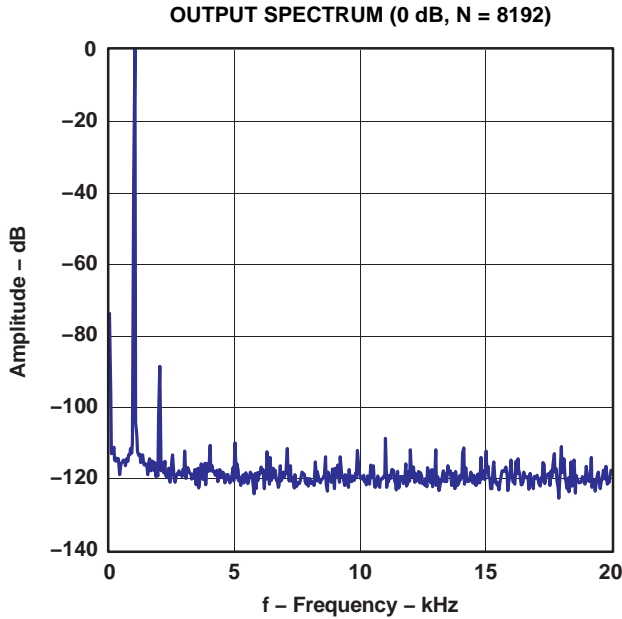

Figure 15.

G015

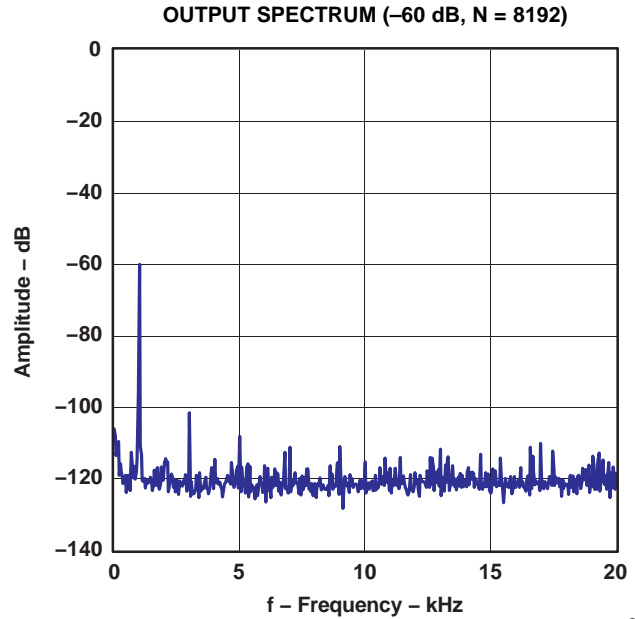

Figure 16.

G016

SUPPLY CURRENT

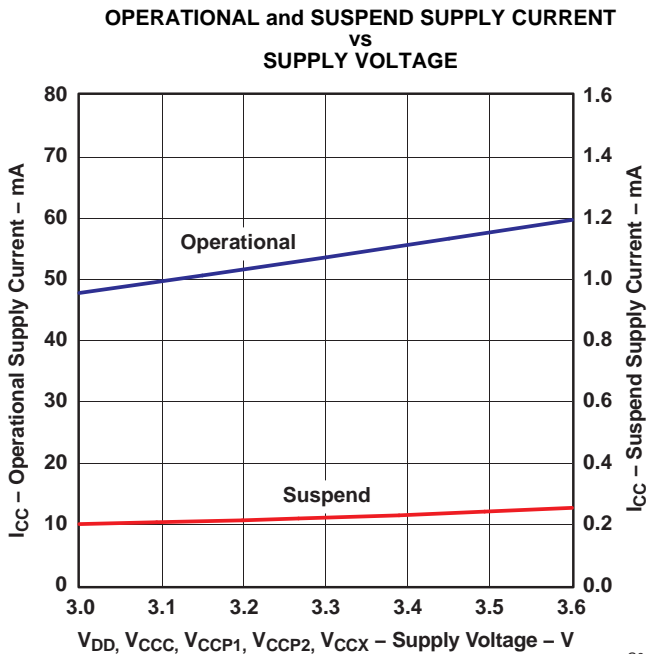

Figure 17.

G017

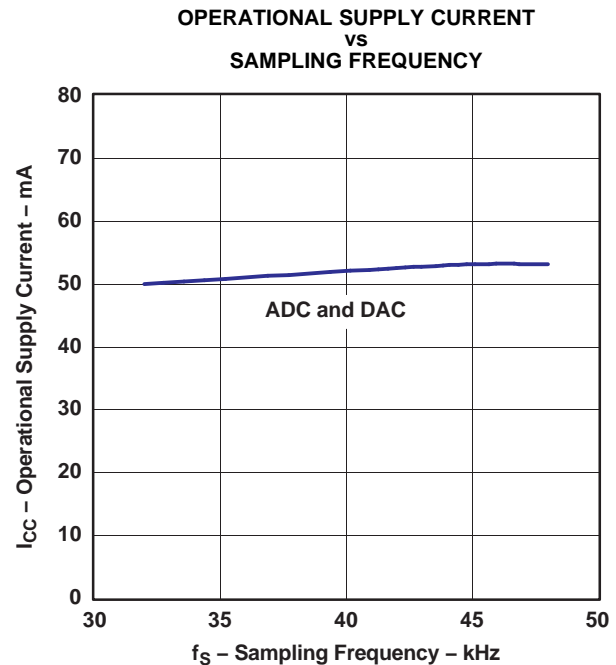

Figure 18.

G018

TYPICAL CHARACTERISTICS (continued)

All specifications at $T_A = 25^\circ\text{C}$, $V_{DD} = V_{CC} = V_{CCP1} = V_{CCP2} = V_{CCX} = 3.3\text{ V}$, $f_s = 44.1\text{ kHz}$, $f_{IN} = 1\text{ kHz}$, 16-bit data, unless otherwise noted.

ADC DIGITAL DECIMATION FILTER FREQUENCY RESPONSE

OVERALL CHARACTERISTICS

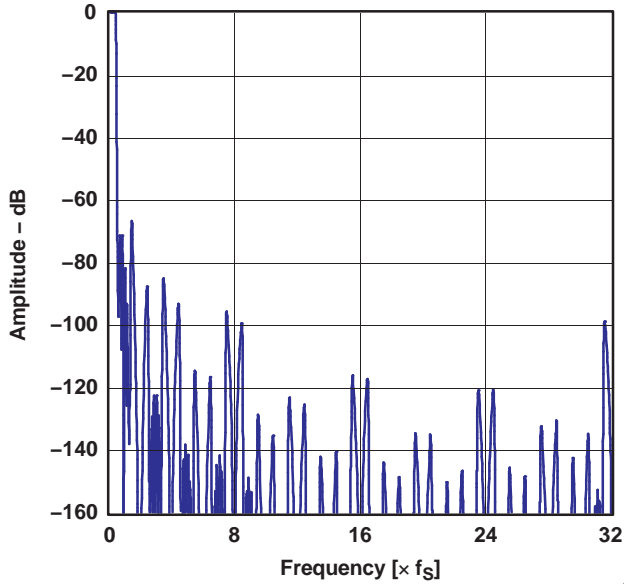

Figure 19.

G019

STOP-BAND ATTENUATION

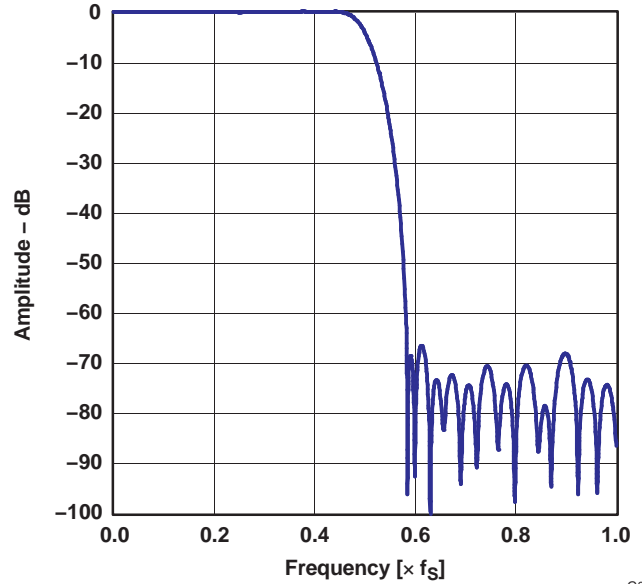

Figure 20.

G020

PASS-BAND RIPPLE

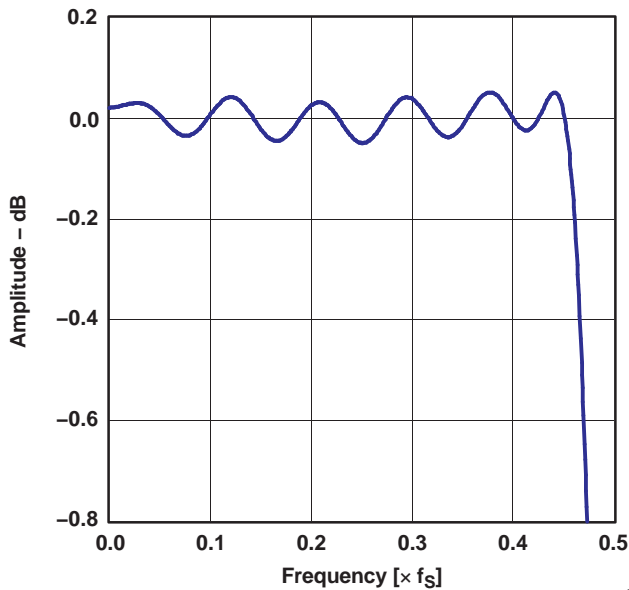

Figure 21.

G021

TRANSITION-BAND RESPONSE

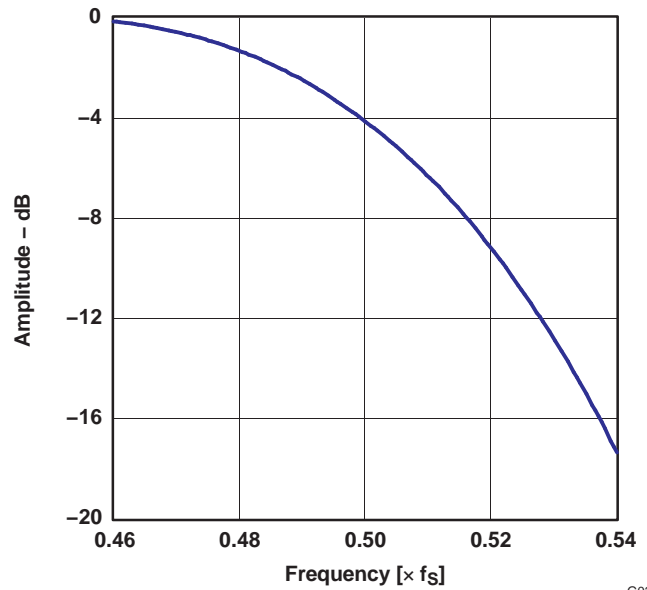

Figure 22.

G022

TYPICAL CHARACTERISTICS (continued)

All specifications at $T_A = 25^\circ\text{C}$, $V_{DD} = V_{CC} = V_{CCP1} = V_{CCP2} = V_{CCX} = 3.3\text{ V}$, $f_s = 44.1\text{ kHz}$, $f_{IN} = 1\text{ kHz}$, 16-bit data, unless otherwise noted.

ADC DIGITAL HIGH-PASS FILTER FREQUENCY RESPONSE

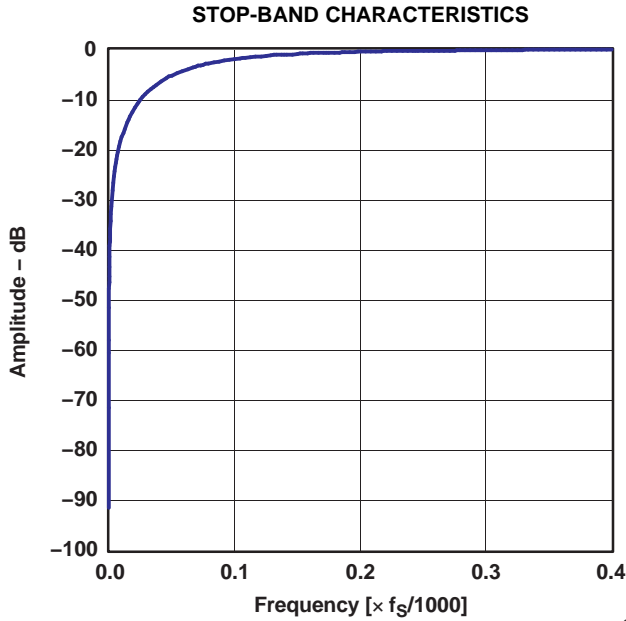

Figure 23.

G023

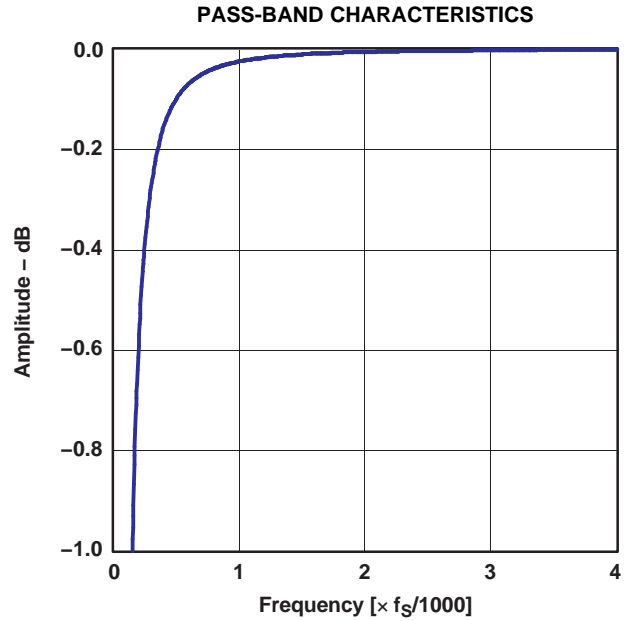

Figure 24.

G024

ADC ANALOG ANTIALIASING FILTER FREQUENCY RESPONSE

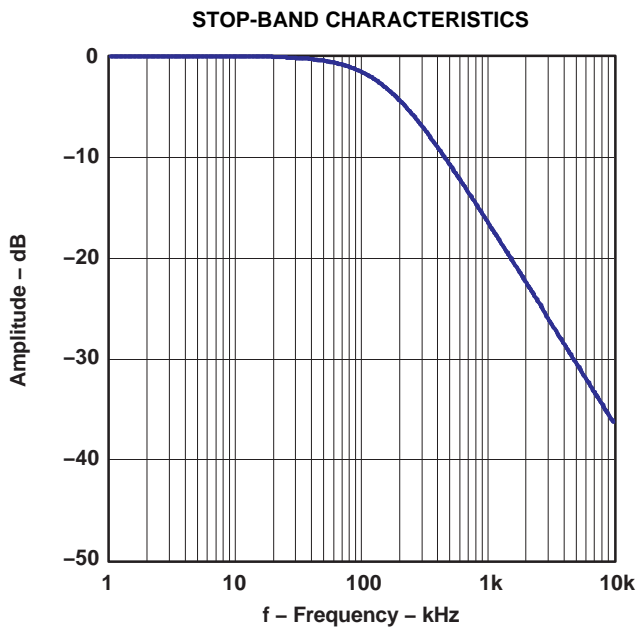

Figure 25.

G025

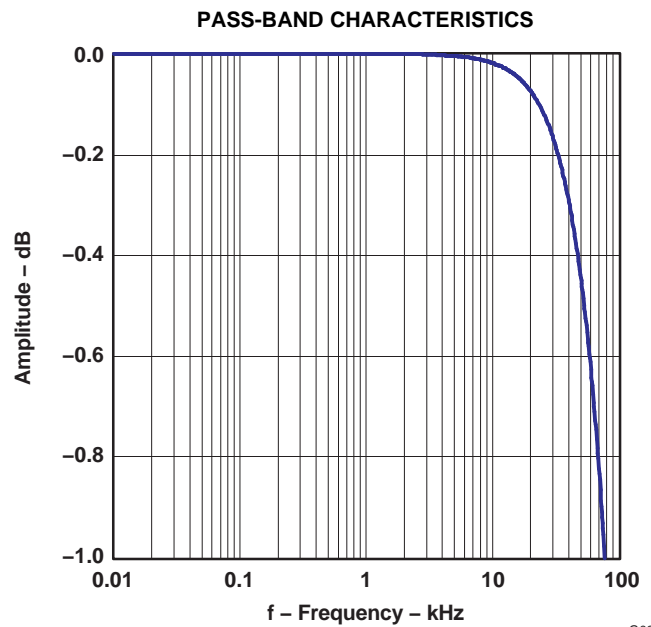

Figure 26.

G026

TYPICAL CHARACTERISTICS (continued)

All specifications at $T_A = 25^\circ\text{C}$, $V_{DD} = V_{CCC} = V_{CCP1} = V_{CCP2} = V_{CCX} = 3.3\text{ V}$, $f_s = 44.1\text{ kHz}$, $f_{IN} = 1\text{ kHz}$, 16-bit data, unless otherwise noted.

DAC DIGITAL INTERPOLATION FILTER FREQUENCY RESPONSE

STOP-BAND ATTENUATION

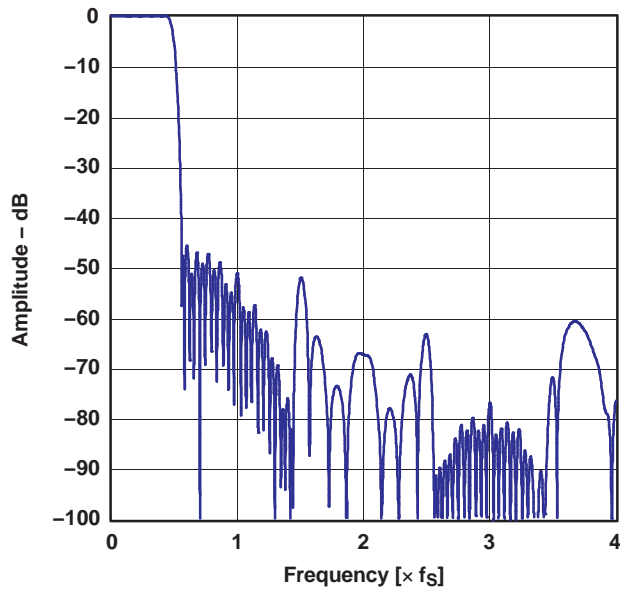

G027

Figure 27.

PASS-BAND RIPPLE

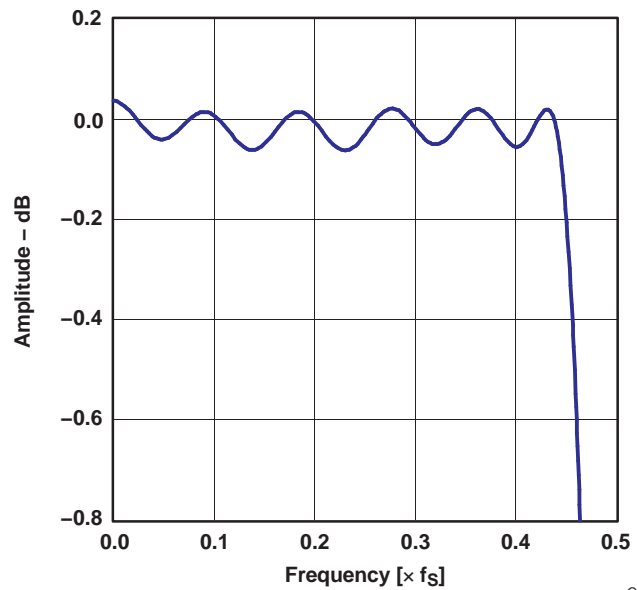

G028

Figure 28.

TRANSITION-BAND RESPONSE

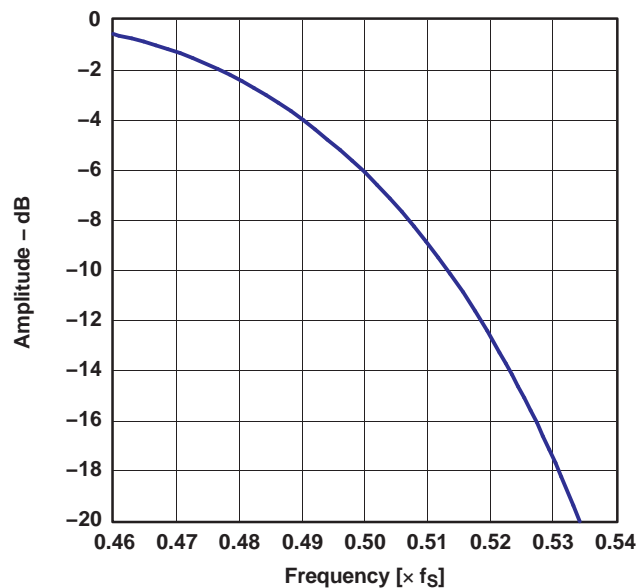

G029

Figure 29.

TYPICAL CHARACTERISTICS (continued)

All specifications at $T_A = 25^\circ\text{C}$, $V_{DD} = V_{CCC} = V_{CCP1} = V_{CCP2} = V_{CCX} = 3.3\text{ V}$, $f_s = 44.1\text{ kHz}$, $f_{IN} = 1\text{ kHz}$, 16-bit data, unless otherwise noted.

DAC ANALOG FIR FILTER FREQUENCY RESPONSE

STOP-BAND CHARACTERISTICS

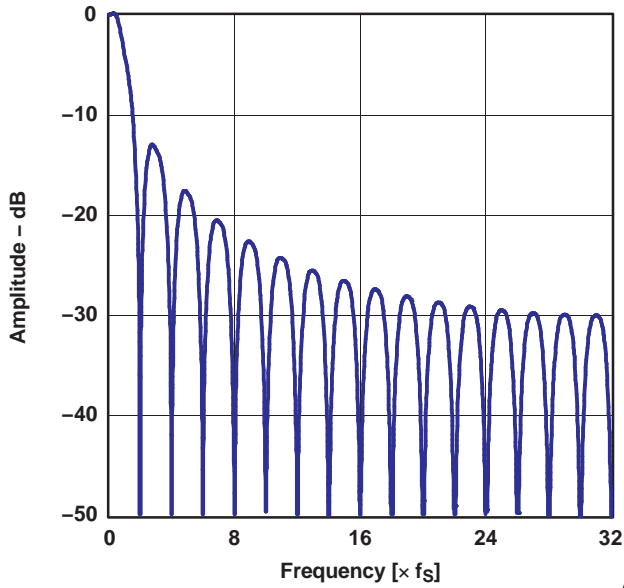

Figure 30.

PASS-BAND CHARACTERISTICS

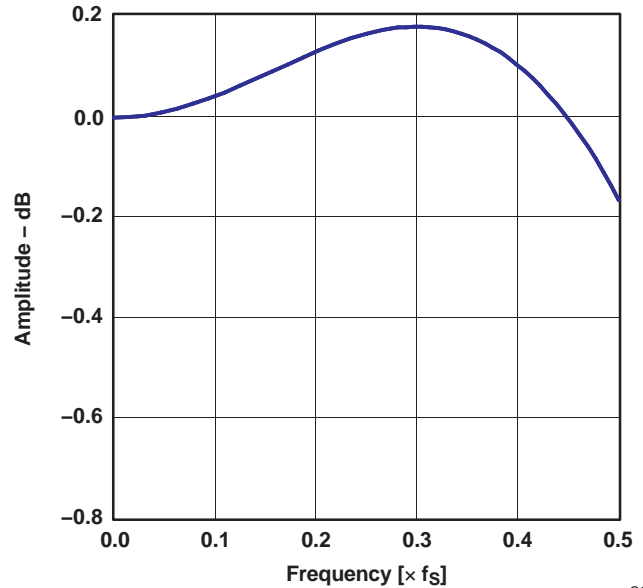

Figure 31.

DAC ANALOG LOW-PASS FILTER FREQUENCY RESPONSE

STOP-BAND CHARACTERISTICS

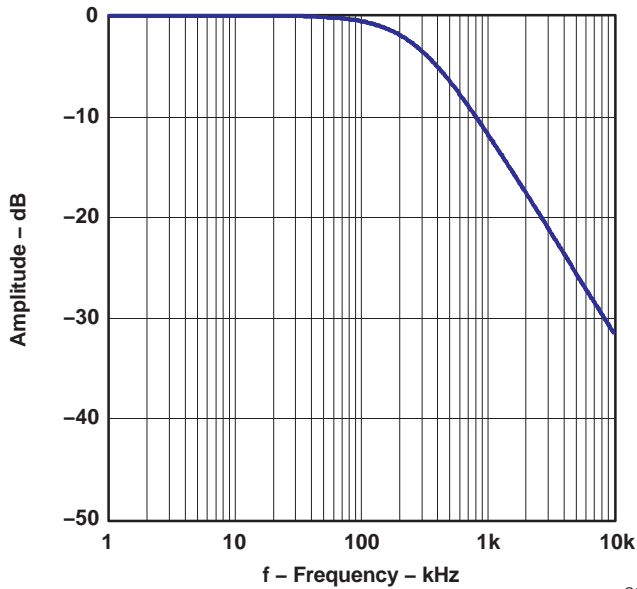

Figure 32.

PASS-BAND CHARACTERISTICS

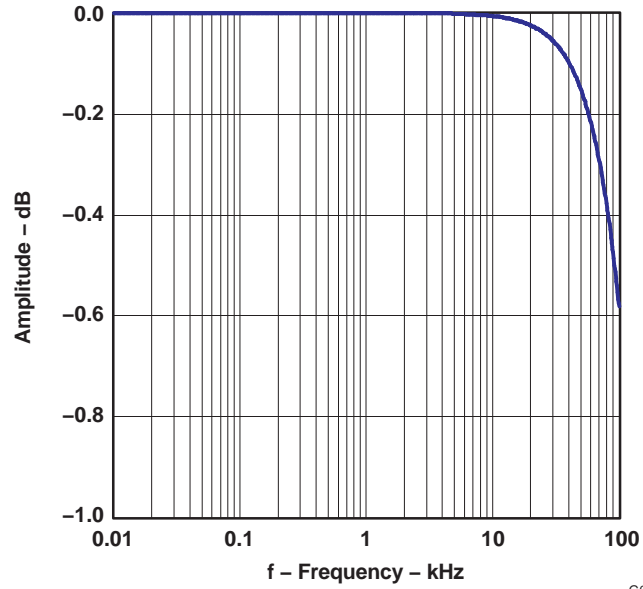

Figure 33.

DETAILED DESCRIPTION

USB INTERFACE

Control data and audio data are transferred to the PCM2901/2903 via D+ (pin 1) and D– (pin 2). All data to/from the PCM2901/2903 is transferred at full speed. The device descriptor contains the information described in Table 1. The device descriptor can be modified on request; contact a Texas Instruments representative for details.

Table 1. Device Descriptor

USB revision	1.1 compliant
Device class	0x00 (device-defined interface level)
Device subclass	0x00 (not specified)
Device protocol	0x00 (not specified)
Max packet size for end-point 0	8 bytes
Vendor ID	0x08BB (default value, can be modified)
Product ID	0x2901 / 0x2903 (default value, can be modified)
Device release number	1.0 (0x0100)
Number of configurations	1
Vendor strings	String #1 (see Table 3)
Product strings	String #2 (see Table 3)
Serial number	Not supported

The configuration descriptor contains the information described in [Table 2](#). The configuration descriptor can be modified on request; contact a Texas Instruments representative for details.

Table 2. Configuration Descriptor

Interface	Four interfaces
Power attribute	0xC0 (Self-powered, no remote wakeup)
Maximum power	0x00 (0 mA. Default value, can be modified)

The string descriptor contains the information described in [Table 3](#). The string descriptor can be modified on request; contact a Texas Instruments representative for details.

Table 3. String Descriptor

#0	0x0409
#1	Burr-Brown from TI (default value, can be modified)
#2	USB audio codec (default value, can be modified)

DEVICE CONFIGURATON

Figure 34 illustrates the USB audio function topology. The PCM2901/2903 has four interfaces. Each interface is constructed by alternative settings.

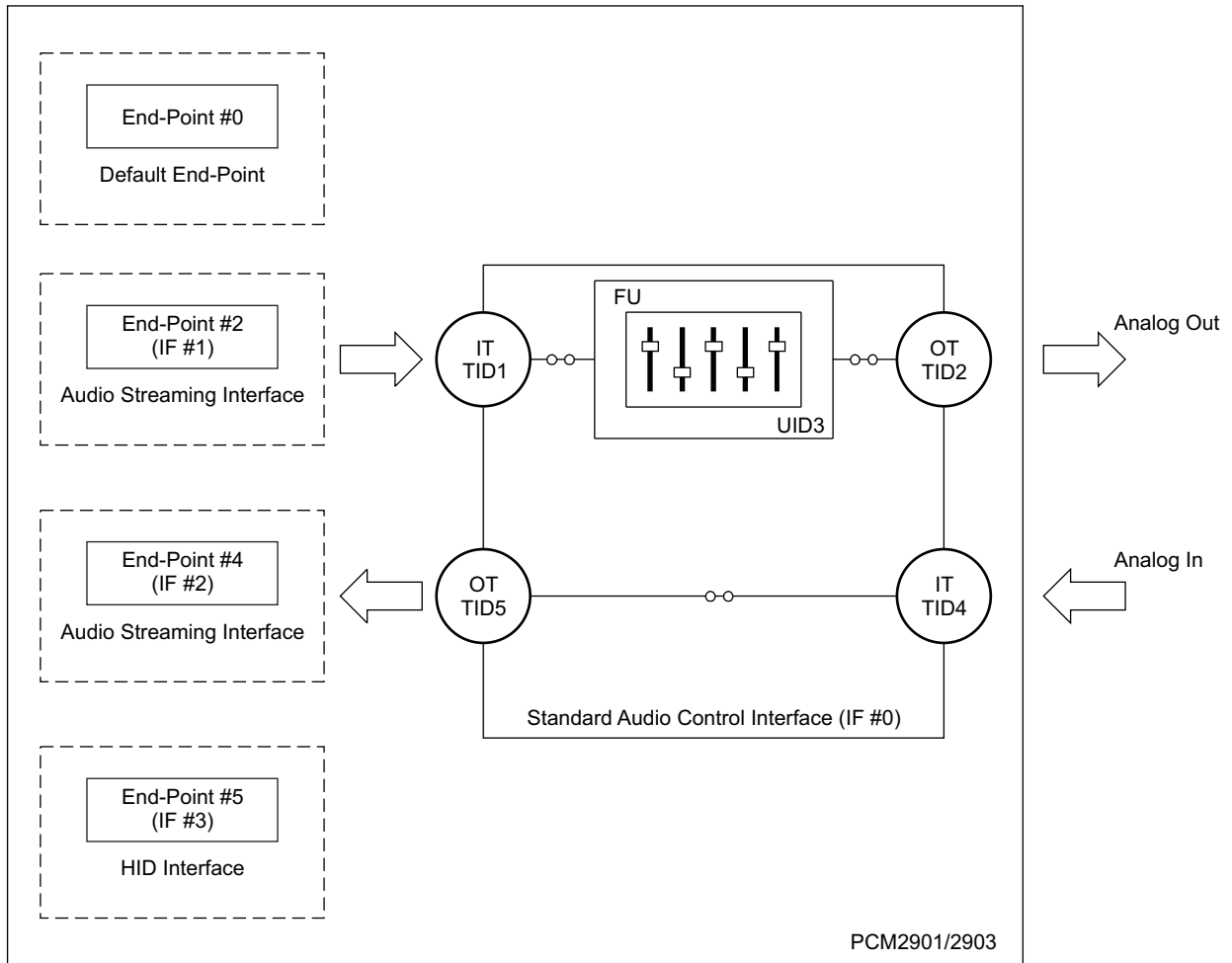

M0024-04

Figure 34. USB Audio Function Topology

Interface #0

Interface #0 is defined as the control interface. Alternative setting #0 is the only possible setting for interface #0. Alternative setting #0 describes the standard audio control interface. A terminal constructs the audio control interface. The PCM2901/2903 has the following five terminals.

- Input terminal (IT #1) for isochronous-out stream
- Output terminal (OT #2) for audio analog output
- Feature unit (FU #3) for DAC digital attenuator
- Input terminal (IT #4) for audio analog input
- Output terminal (OT #5) for isochronous-in stream

Input terminal #1 is defined as USB stream (terminal type 0x0101). Input terminal #1 can accept 2-channel audio streams constructed by left and right channels. Output terminal #2 is defined as a speaker (terminal type 0x0301). Input terminal #4 is defined as microphone (terminal type 0x0201). Output terminal #5 is defined as a USB stream (terminal type 0x0101). Output terminal #5 can generate 2-channel audio streams constructed by left and right channels. Feature unit #3 supports the following sound control features.

- Volume control
- Mute control

The built-in digital volume controller can be manipulated by an audio class specific request from 0 dB to –64 dB in 1-dB steps. Changes are made by incrementing or decrementing by one step (1 dB) for every $1/f_s$ time interval until the volume level has reached the requested value. Each channel can be set for different values. The master volume control is not supported. A request to the master volume is stalled and ignored. The built-in digital mute controller can be manipulated by audio class-specific request. A master mute control request is acceptable. A request to an individual channel is stalled and ignored.

Interface #1

Interface #1 is defined as the audio streaming data-out interface. Interface #1 has the following seven alternative settings. Alternative setting #0 is the zero-bandwidth setting.

ALTERNATIVE SETTING	DATA FORMAT			TRANSFER MODE	SAMPLING RATE (kHz)
00	Zero bandwidth				
01	16 bit	Stereo	2s complement (PCM)	Adaptive	32, 44.1, 48
02	16 bit	Mono	2s complement (PCM)	Adaptive	32, 44.1, 48
03	8 bit	Stereo	2s complement (PCM)	Adaptive	32, 44.1, 48
04	8 bit	Mono	2s complement (PCM)	Adaptive	32, 44.1, 48
05	8 bit	Stereo	Offset binary (PCM8)	Adaptive	32, 44.1, 48
06	8 bit	Mono	Offset binary (PCM8)	Adaptive	32, 44.1, 48

Interface #2

Interface #2 is defined as the audio streaming data-in interface. Interface #2 has the following 19 alternative settings. Alternative setting #0 is the zero-bandwidth setting. All other alternative settings are operational settings.

ALTERNATIVE SETTING	DATA FORMAT			TRANSFER MODE	SAMPLING RATE (kHz)
00	Zero bandwidth				
01	16 bit	Stereo	2s complement (PCM)	Asynchronous	48
02	16 bit	Mono	2s complement (PCM)	Asynchronous	48
03	16 bit	Stereo	2s complement (PCM)	Asynchronous	44.1
04	16 bit	Mono	2s complement (PCM)	Asynchronous	44.1
05	16 bit	Stereo	2s complement (PCM)	Asynchronous	32
06	16 bit	Mono	2s complement (PCM)	Asynchronous	32
07	16 bit	Stereo	2s complement (PCM)	Asynchronous	22.05
08	16 bit	Mono	2s complement (PCM)	Asynchronous	22.05
09	16 bit	Stereo	2s complement (PCM)	Asynchronous	16
0A	16 bit	Mono	2s complement (PCM)	Asynchronous	16
0B	8 bit	Stereo	2s complement (PCM)	Asynchronous	16
0C	8 bit	Mono	2s complement (PCM)	Asynchronous	16
0D	8 bit	Stereo	2s complement (PCM)	Asynchronous	8
0E	8 bit	Mono	2s complement (PCM)	Asynchronous	8
0F	16 bit	Stereo	2s complement (PCM)	Synchronous	11.025
10	16 bit	Mono	2s complement (PCM)	Synchronous	11.025
11	8 bit	Stereo	2s complement (PCM)	Synchronous	11.025
12	8 bit	Mono	2s complement (PCM)	Synchronous	11.025

Interface #3

Interface #3 is defined as the interrupt data-in interface. Alternative setting #0 is the only possible setting for interface #3. Interface #3 constructs the HID consumer control device. Interface #3 reports the following three key statuses.

- Mute (0xE209)
- Volume up (0xE909)
- Volume down (0xEA09)

End-Points

The PCM2901/2903 has the following four end-points.

- Control end-point (EP #0)
- Isochronous-out audio data stream end-point (EP #2)
- Isochronous-in audio data stream end-point (EP #4)
- HID end-point (EP #5)

The control end-point is a default end-point. The control end-point is used to control all functions of the PCM2901/2903 by the standard USB request and USB audio-class-specific request from the host. The isochronous-out audio data stream end-point is an audio sink end-point, which receives the PCM audio data. The isochronous-out audio data stream end-point accepts the adaptive transfer mode. The isochronous-in audio data stream end-point is an audio source end-point, which transmits the PCM audio data. The isochronous-in audio data stream end-point uses asynchronous transfer mode. The HID end-point is an interrupt-in end-point. HID end-point reports HID0, HID1, and HID2 pin status every 32 ms.

The human interface device (HID) pins are defined as consumer control devices. The HID function is designed as an independent end-point from both isochronous-in and -out end-points. This means that the device affected by the HID operation depends on the host software. Typically, the HID function affects the primary audio-out device.

Clock and Reset

The PCM2901/2903 requires a 12-MHz (± 500 ppm) clock for the USB and audio function, which can be generated by a built-in crystal oscillator with a 12-MHz crystal resonator or supplied by an external clock. The 12-MHz crystal resonator must be connected to XTI (pin 21) and XTO (pin 20) with one high (1-M Ω) resistor and two small capacitors, the capacitance of which depends on the load capacitance of the crystal resonator. If the external clock is used, the clock must be supplied to XTI, and XTO must be open.

The PCM2901/2903 has an internal power-on reset circuit, which works automatically when V_{DD} (pin 27) exceeds 2.5 V typical (2.7 V to 2.2 V), and about 700 μ s is required until internal reset release.)

Digital Audio Interface (PCM2903)

The PCM2903 employs both S/PDIF input and output. Isochronous-out data from the host is encoded to the S/PDIF output and the DAC analog output. Input data is selected as either S/PDIF or ADC analog input. When the device detects an S/PDIF input and successfully locks on the received data, the isochronous-in transfer data source is automatically selected from S/PDIF itself; otherwise, the data source is selected to ADC analog input.

Supported Input Data (PCM2903)

The following data formats are accepted by the S/PDIF input and output. All other data formats are unable to use S/PDIF.

- 48-kHz 16-bit stereo
- 44.1-kHz 16-bit stereo
- 32-kHz 16-bit stereo

Mismatch between input data format and host command may cause unexpected results except in the following conditions.

- Record monaural format from stereo data input at the same data rate
- Record 8-bit format from 16-bit data input at the same data rate

A combination of the foregoing conditions is not accepted.

For playback, all possible data-rate source is converted to 16-bit stereo format at the same source data rate.

Channel Status Information (PCM2903)

The channel status information is fixed as consumer application, PCM mode, copyright, and digital/digital converter. All other bits are fixed as 0s except for the sample frequency, which is set automatically according to the data received through the USB.

Copyright Management (PCM2903)

Isochronous-in data is affected by the serial copy management system (SCMS). Where receiving digital audio data that is indicated as original data in the control bit, input digital audio data transfers to the host. If the data is indicated as first generation or higher, transferred data is selected to analog input.

Digital audio data output is always encoded as original with SCMS control.

The implementation of this feature is an option for the customer. Note that it is the user's responsibility whether they implement this feature in their product or not.

INTERFACE SEQUENCE

Power On, Attach, and Playback Sequence

The PCM2901/2903 is ready for setup when the reset sequence has finished and the USB bus is attached. In order to perform certain reset sequences defined in the USB specification, V_{DD} , V_{CC} , V_{CCP1} , V_{CCP2} , and V_{CCX} must rise up with 10 ms / 3.3 V. After connection has been established by setup, the PCM2901/2903 is ready to accept USB audio data. While waiting, the audio data (idle state) and analog output are set to bipolar zero (BPZ).

When receiving the audio data, the PCM2901/2903 stores the first audio packet, which contained 1-ms audio data, into the internal storage buffer. The PCM2901/2903 starts playing the audio data when detecting the following start of frame (SOF) packet.

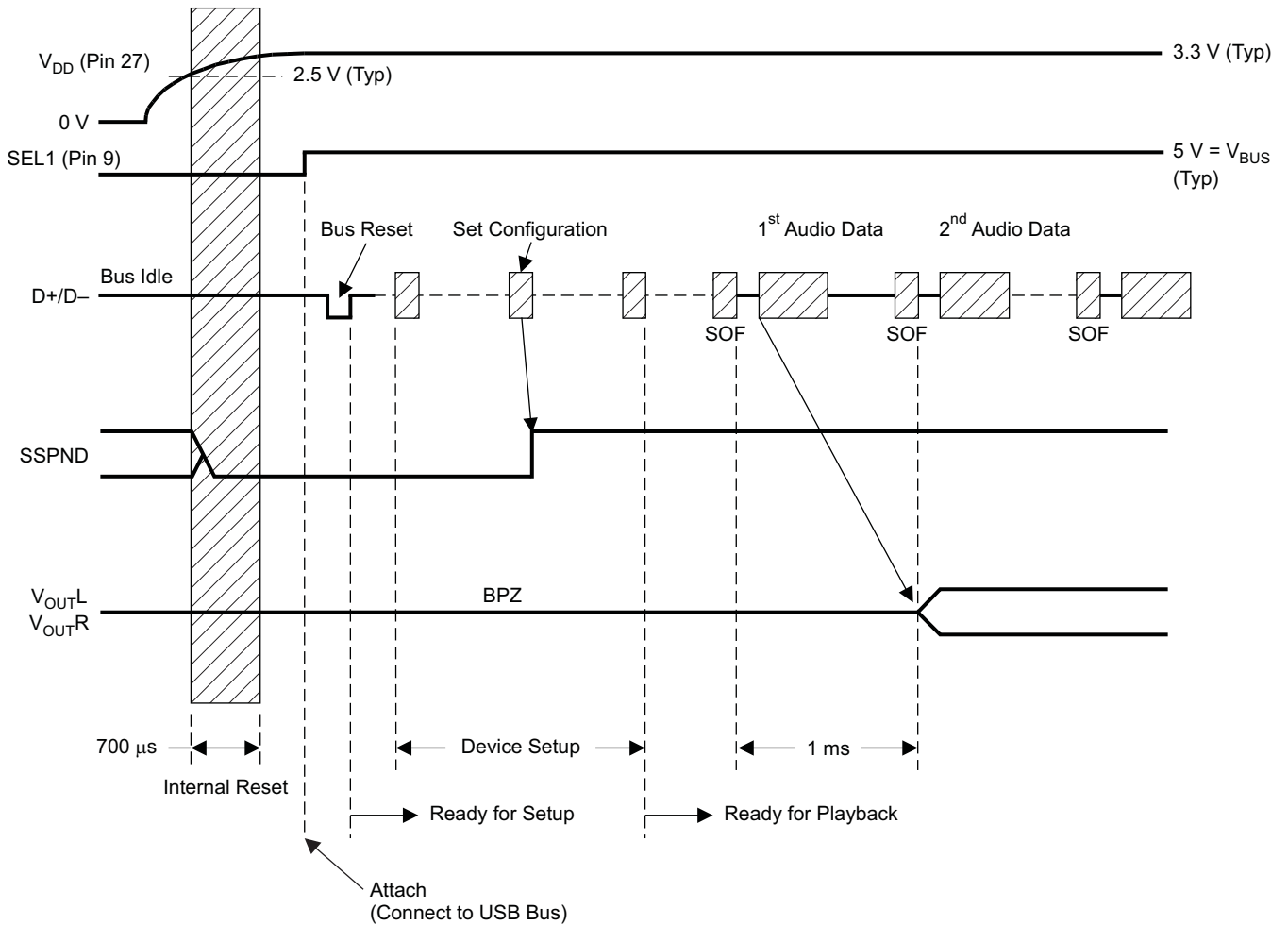

T0055-03

Figure 35. Attach After Power On

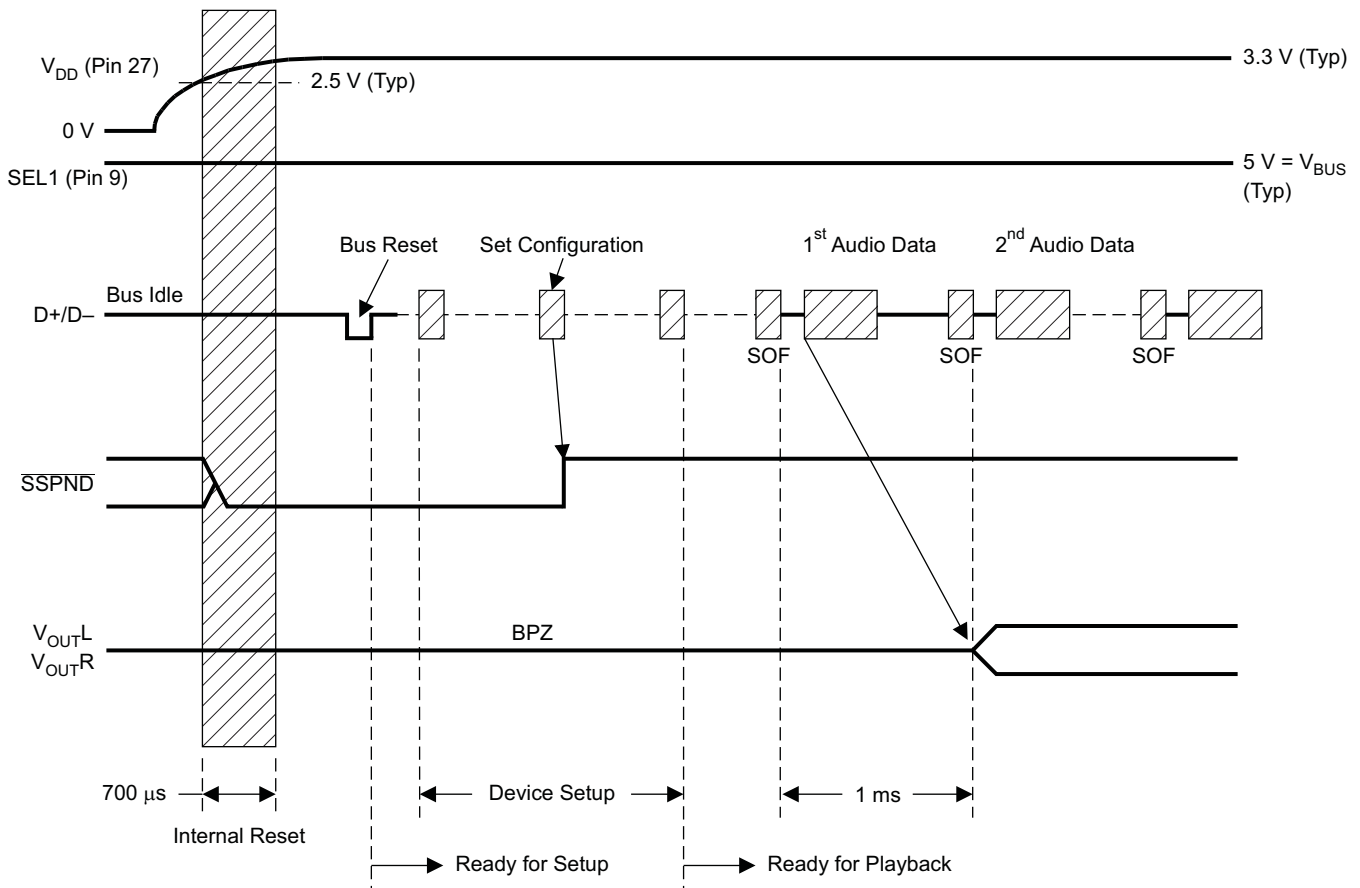

T0273-01

Figure 36. Power-On Under Attach

Play, Stop, and Detach Sequence

When the host finishes or aborts the playback, the PCM2901/2903 stops playing after the last audio data has played.

Record Sequence

The PCM2901/2903 starts the audio capture into the internal memory after receiving the SET_INTERFACE command.

Suspend and Resume Sequence

The PCM2901/2903 enters the suspend state after it detects a constant idle state on the USB bus, approximately 5 ms. While the PCM2901/2903 enters the suspend state, the $SSPND$ flag (pin 28) is asserted. The PCM2901/2903 wakes up immediately after detecting a non-idle state on the USB bus.

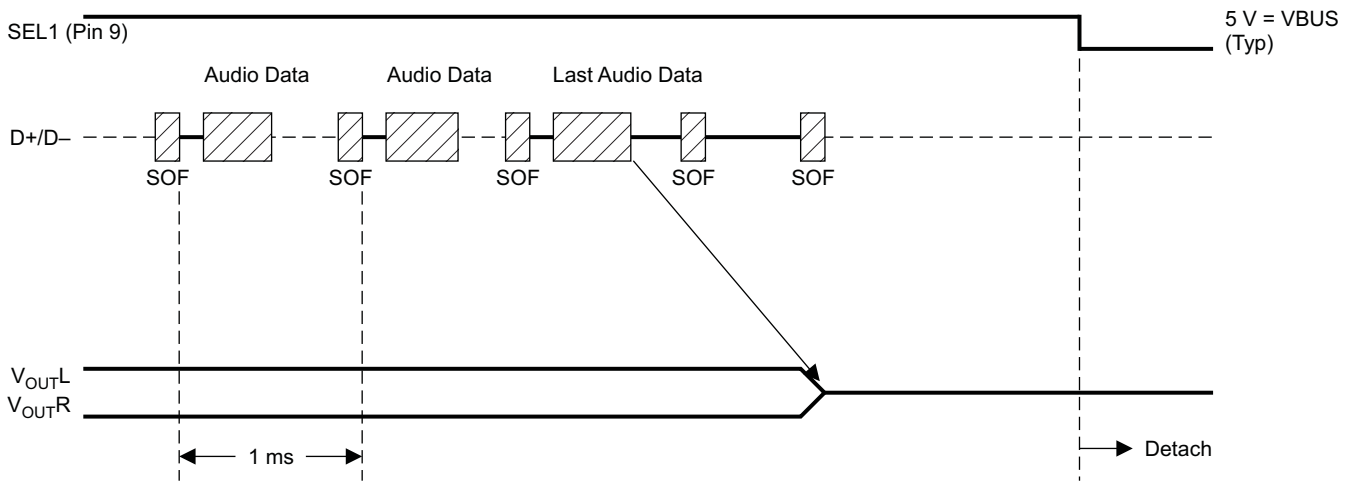

T0056-03

Figure 37. Play, Stop, and Detach

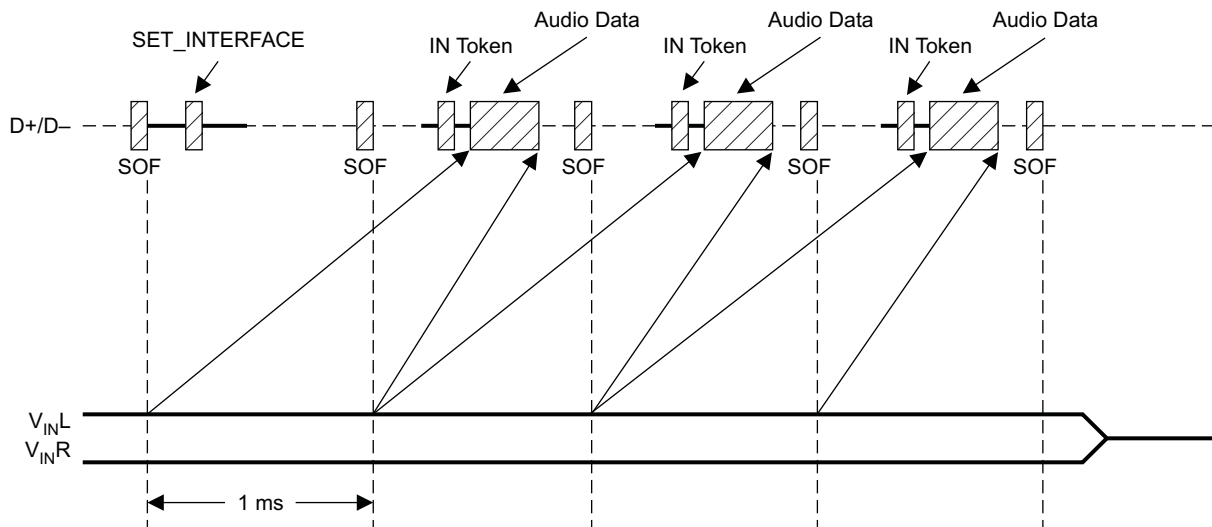

T0259-01

Figure 38. Record Sequence

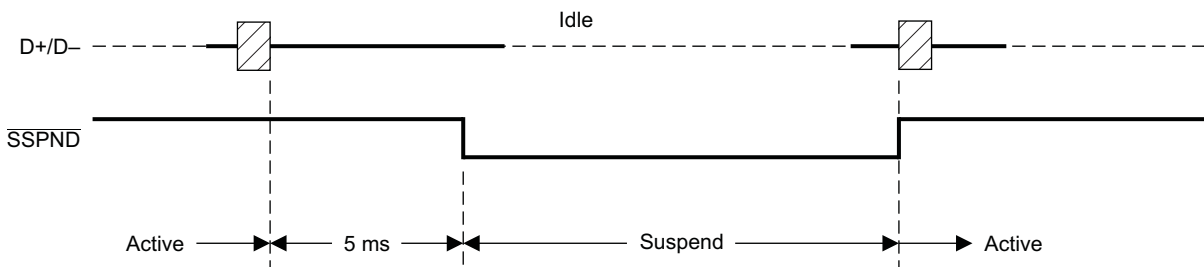

T0057-02

Figure 39. Suspend and Resume

PCM2901 TYPICAL CIRCUIT CONNECTION

Figure 40 illustrates a typical circuit connection for a simple application. The circuit illustrated is for information only. The whole board design should be considered to meet the USB specification as a USB-compliant product.

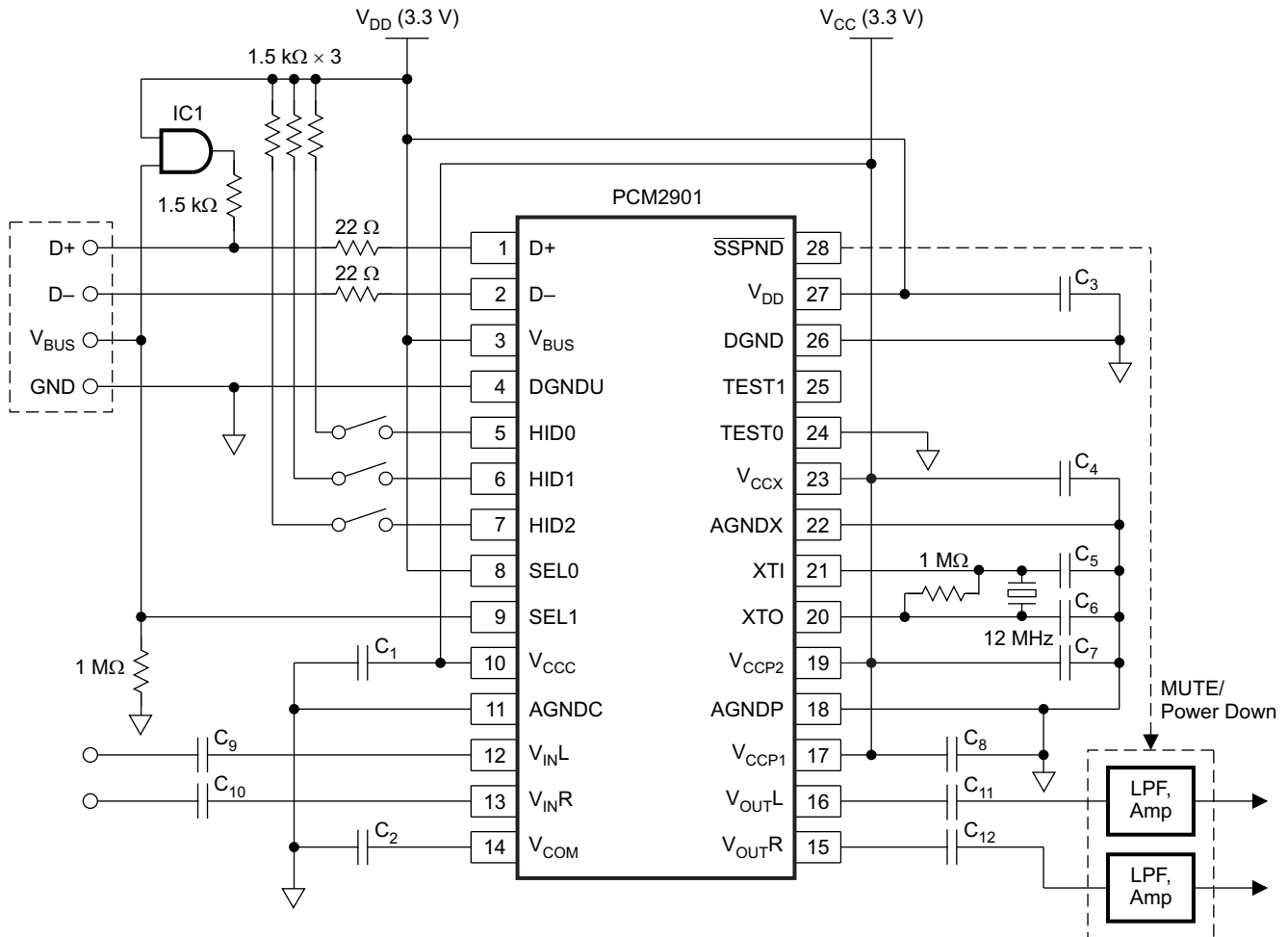

S0312-01

NOTE:

- IC1 must be driven by V_{DD} with a 5-V tolerant input.
- C₁, C₂, C₃, C₄, C₇, C₈: 10 μF
- C₅, C₆: 10 pF to 33 pF (depending on crystal resonator)
- C₉, C₁₀, C₁₁, C₁₂: The capacitance may vary depending on design.

Figure 40. Self-Powered Configuration

PCM2903 TYPICAL CIRCUIT CONNECTION

Figure 41 illustrates a typical circuit connection for a simple application. The circuit illustrated is for information only. The whole board design should be considered to meet the USB specification as a USB-compliant product.

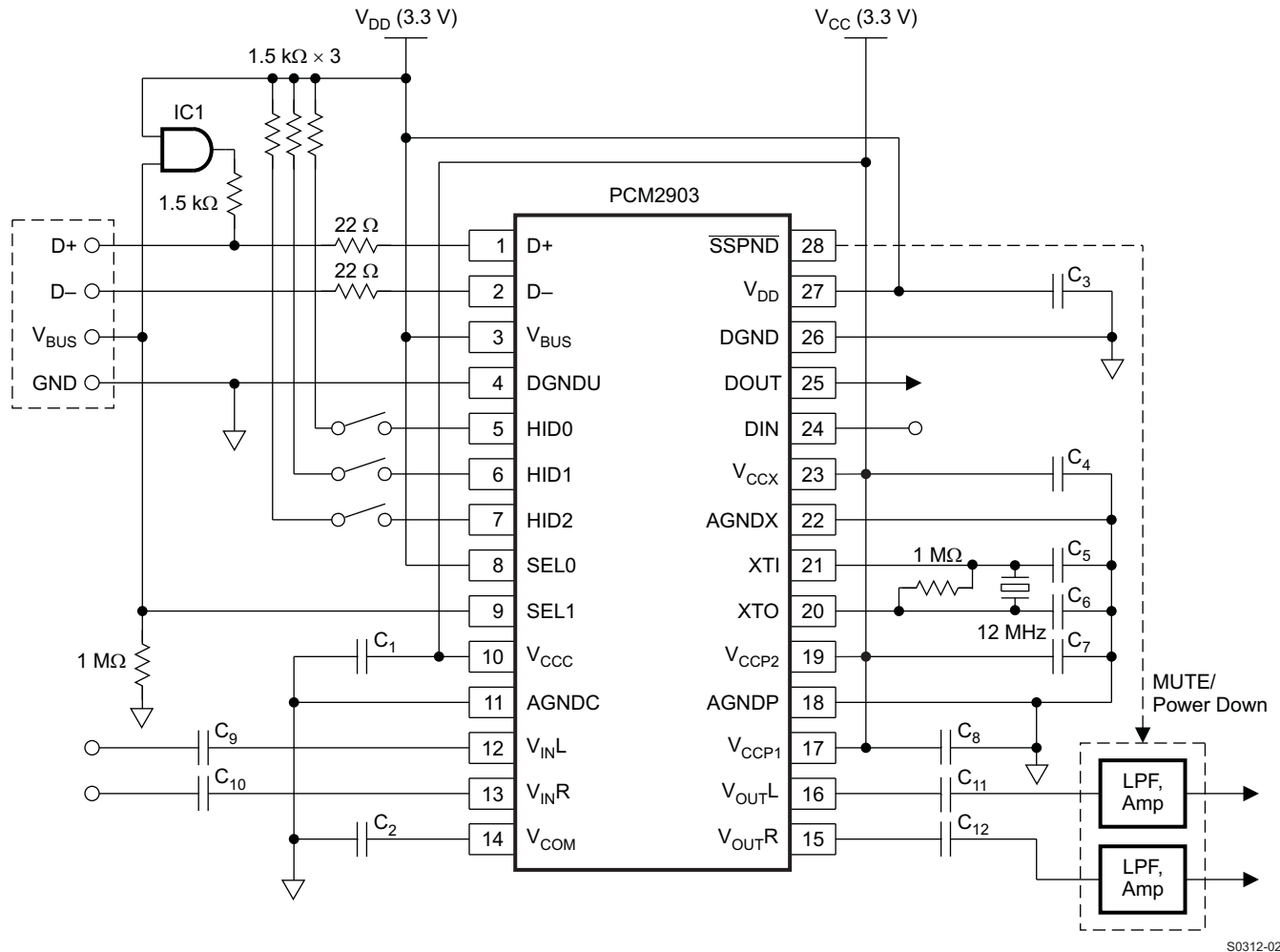

NOTE:

- IC1 must be driven by V_{DD} with a 5-V tolerant input.
- $C_1, C_2, C_3, C_4, C_7, C_8$: 10 μF
- C_5, C_6 : 10 pF to 33 pF (depending on crystal resonator)
- $C_9, C_{10}, C_{11}, C_{12}$: The capacitance may vary depending on design.

Figure 41. Self-Powered Configuration

S0312-02

APPENDIX

Operating Environment

For current information on the PCM2901/2903 operating environment, see the *Updated Operating Environments for PCM270X, PCM290X Applications* application report, [SLAA374](#).

REVISION HISTORY

Changes from Revision B (March 2002) to Revision C	Page
• Deleted operating environment information from data sheet and added reference to application report	30

PACKAGING INFORMATION

Orderable Device	Status ⁽¹⁾	Package Type	Package Drawing	Pins	Package Qty	Eco Plan ⁽²⁾	Lead/Ball Finish	MSL Peak Temp ⁽³⁾
PCM2901E	ACTIVE	SSOP	DB	28	47	Green (RoHS & no Sb/Br)	CU NIPDAU	Level-1-260C-UNLIM
PCM2901E/2K	ACTIVE	SSOP	DB	28	2000	Green (RoHS & no Sb/Br)	CU NIPDAU	Level-1-260C-UNLIM
PCM2901E/2KG4	ACTIVE	SSOP	DB	28	2000	Green (RoHS & no Sb/Br)	CU NIPDAU	Level-1-260C-UNLIM
PCM2901EG4	ACTIVE	SSOP	DB	28	47	Green (RoHS & no Sb/Br)	CU NIPDAU	Level-1-260C-UNLIM
PCM2903E	ACTIVE	SSOP	DB	28	47	Green (RoHS & no Sb/Br)	CU NIPDAU	Level-1-260C-UNLIM
PCM2903E/2K	ACTIVE	SSOP	DB	28	2000	Green (RoHS & no Sb/Br)	CU NIPDAU	Level-1-260C-UNLIM
PCM2903E/2KG4	ACTIVE	SSOP	DB	28	2000	Green (RoHS & no Sb/Br)	CU NIPDAU	Level-1-260C-UNLIM
PCM2903EG4	ACTIVE	SSOP	DB	28	47	Green (RoHS & no Sb/Br)	CU NIPDAU	Level-1-260C-UNLIM

⁽¹⁾ The marketing status values are defined as follows:

ACTIVE: Product device recommended for new designs.

LIFEBUY: TI has announced that the device will be discontinued, and a lifetime-buy period is in effect.

NRND: Not recommended for new designs. Device is in production to support existing customers, but TI does not recommend using this part in a new design.

PREVIEW: Device has been announced but is not in production. Samples may or may not be available.

OBSOLETE: TI has discontinued the production of the device.

⁽²⁾ Eco Plan - The planned eco-friendly classification: Pb-Free (RoHS), Pb-Free (RoHS Exempt), or Green (RoHS & no Sb/Br) - please check <http://www.ti.com/productcontent> for the latest availability information and additional product content details.

TBD: The Pb-Free/Green conversion plan has not been defined.

Pb-Free (RoHS): TI's terms "Lead-Free" or "Pb-Free" mean semiconductor products that are compatible with the current RoHS requirements for all 6 substances, including the requirement that lead not exceed 0.1% by weight in homogeneous materials. Where designed to be soldered at high temperatures, TI Pb-Free products are suitable for use in specified lead-free processes.

Pb-Free (RoHS Exempt): This component has a RoHS exemption for either 1) lead-based flip-chip solder bumps used between the die and package, or 2) lead-based die adhesive used between the die and leadframe. The component is otherwise considered Pb-Free (RoHS compatible) as defined above.

Green (RoHS & no Sb/Br): TI defines "Green" to mean Pb-Free (RoHS compatible), and free of Bromine (Br) and Antimony (Sb) based flame retardants (Br or Sb do not exceed 0.1% by weight in homogeneous material)

⁽³⁾ MSL, Peak Temp. -- The Moisture Sensitivity Level rating according to the JEDEC industry standard classifications, and peak solder temperature.

Important Information and Disclaimer:The information provided on this page represents TI's knowledge and belief as of the date that it is provided. TI bases its knowledge and belief on information provided by third parties, and makes no representation or warranty as to the accuracy of such information. Efforts are underway to better integrate information from third parties. TI has taken and continues to take reasonable steps to provide representative and accurate information but may not have conducted destructive testing or chemical analysis on incoming materials and chemicals. TI and TI suppliers consider certain information to be proprietary, and thus CAS numbers and other limited information may not be available for release.

In no event shall TI's liability arising out of such information exceed the total purchase price of the TI part(s) at issue in this document sold by TI to Customer on an annual basis.

TAPE AND REEL BOX INFORMATION



A0	Dimension designed to accommodate the component width
B0	Dimension designed to accommodate the component length
K0	Dimension designed to accommodate the component thickness
W	Overall width of the carrier tape
P1	Pitch between successive cavity centers

QUADRANT ASSIGNMENTS FOR PIN 1 ORIENTATION IN TAPE



Device	Package	Pins	Site	Reel Diameter (mm)	Reel Width (mm)	A0 (mm)	B0 (mm)	K0 (mm)	P1 (mm)	W (mm)	Pin1 Quadrant
PCM2901E/2K	DB	28	SITE 49	330	17	8.5	10.8	2.4	12	16	Q1
PCM2903E/2K	DB	28	SITE 49	330	17	8.5	10.8	2.4	12	16	Q1

TAPE AND REEL BOX DIMENSIONS



Device	Package	Pins	Site	Length (mm)	Width (mm)	Height (mm)
PCM2901E/2K	DB	28	SITE 49	0.0	0.0	0.0
PCM2903E/2K	DB	28	SITE 49	0.0	0.0	0.0

DB (R-PDSO-G**)

PLASTIC SMALL-OUTLINE

28 PINS SHOWN



- NOTES: A. All linear dimensions are in millimeters.
 B. This drawing is subject to change without notice.
 C. Body dimensions do not include mold flash or protrusion not to exceed 0,15.
 D. Falls within JEDEC MO-150

IMPORTANT NOTICE

Texas Instruments Incorporated and its subsidiaries (TI) reserve the right to make corrections, modifications, enhancements, improvements, and other changes to its products and services at any time and to discontinue any product or service without notice. Customers should obtain the latest relevant information before placing orders and should verify that such information is current and complete. All products are sold subject to TI's terms and conditions of sale supplied at the time of order acknowledgment.

TI warrants performance of its hardware products to the specifications applicable at the time of sale in accordance with TI's standard warranty. Testing and other quality control techniques are used to the extent TI deems necessary to support this warranty. Except where mandated by government requirements, testing of all parameters of each product is not necessarily performed.

TI assumes no liability for applications assistance or customer product design. Customers are responsible for their products and applications using TI components. To minimize the risks associated with customer products and applications, customers should provide adequate design and operating safeguards.

TI does not warrant or represent that any license, either express or implied, is granted under any TI patent right, copyright, mask work right, or other TI intellectual property right relating to any combination, machine, or process in which TI products or services are used. Information published by TI regarding third-party products or services does not constitute a license from TI to use such products or services or a warranty or endorsement thereof. Use of such information may require a license from a third party under the patents or other intellectual property of the third party, or a license from TI under the patents or other intellectual property of TI.

Reproduction of TI information in TI data books or data sheets is permissible only if reproduction is without alteration and is accompanied by all associated warranties, conditions, limitations, and notices. Reproduction of this information with alteration is an unfair and deceptive business practice. TI is not responsible or liable for such altered documentation. Information of third parties may be subject to additional restrictions.

Resale of TI products or services with statements different from or beyond the parameters stated by TI for that product or service voids all express and any implied warranties for the associated TI product or service and is an unfair and deceptive business practice. TI is not responsible or liable for any such statements.

TI products are not authorized for use in safety-critical applications (such as life support) where a failure of the TI product would reasonably be expected to cause severe personal injury or death, unless officers of the parties have executed an agreement specifically governing such use. Buyers represent that they have all necessary expertise in the safety and regulatory ramifications of their applications, and acknowledge and agree that they are solely responsible for all legal, regulatory and safety-related requirements concerning their products and any use of TI products in such safety-critical applications, notwithstanding any applications-related information or support that may be provided by TI. Further, Buyers must fully indemnify TI and its representatives against any damages arising out of the use of TI products in such safety-critical applications.

TI products are neither designed nor intended for use in military/aerospace applications or environments unless the TI products are specifically designated by TI as military-grade or "enhanced plastic." Only products designated by TI as military-grade meet military specifications. Buyers acknowledge and agree that any such use of TI products which TI has not designated as military-grade is solely at the Buyer's risk, and that they are solely responsible for compliance with all legal and regulatory requirements in connection with such use.

TI products are neither designed nor intended for use in automotive applications or environments unless the specific TI products are designated by TI as compliant with ISO/TS 16949 requirements. Buyers acknowledge and agree that, if they use any non-designated products in automotive applications, TI will not be responsible for any failure to meet such requirements.

Following are URLs where you can obtain information on other Texas Instruments products and application solutions:

Products		Applications	
Amplifiers	amplifier.ti.com	Audio	www.ti.com/audio
Data Converters	dataconverter.ti.com	Automotive	www.ti.com/automotive
DSP	dsp.ti.com	Broadband	www.ti.com/broadband
Interface	interface.ti.com	Digital Control	www.ti.com/digitalcontrol
Logic	logic.ti.com	Military	www.ti.com/military
Power Mgmt	power.ti.com	Optical Networking	www.ti.com/opticalnetwork
Microcontrollers	microcontroller.ti.com	Security	www.ti.com/security
RFID	www.ti-rfid.com	Telephony	www.ti.com/telephony
Low Power Wireless	www.ti.com/lpw	Video & Imaging	www.ti.com/video
		Wireless	www.ti.com/wireless

Mailing Address: Texas Instruments, Post Office Box 655303, Dallas, Texas 75265
Copyright © 2007, Texas Instruments Incorporated